

HMI • SCADA • DCS



Technical Overview

Industrial Automation Software

Company Profile

Since its formation in 1981, Tascomp® products have set the benchmark for ease of use, superior performance, unparalleled support and low cost of ownership. Major companies around the world now specify Prodigy as they recognise the benefits of its reliability and technical excellence.

“We work closely with our systems integrators and end users to understand their needs, provide innovative software solutions and outstanding after sales support. Our open management style and flexible working environment have created a development team that is enthusiastic and committed to our global success.”

Paul Everington – Managing Director.



Contents

- 3 Introduction
- 4 Display Builder
- 6 Trending
- 8 Alarms
- 9 SMS, Email & Fax
- 10 Recipe & Batch Facilities
- 12 User Access & Security
- 13 Online Maintenance
- 14 Reporting & Easy Report
- 15 Multigraph & Proof of Process
- 16 FDA 21 CFR Pt11
- 17 SPC
- 18 Slang
- 20 Controller & ATS
- 21 Database & Configuration Manager
- 22 Thermal Imaging
- 23 Expert Data System
- 24 Downtime Monitoring
- 26 Architecture
- 28 Network & Remote Access
- 29 Prodigy Licensing
- 30 Facilities List
- 32 Application Support Team



All trade marks are recognised as the property of their respective owners. Tascomp® reserves the right to change Prodigy's specification without prior notice.

Introduction

You wouldn't use a different word processor in each section of your office so why put up with different industrial software packages to monitor, control and analyse your manufacturing operations?

The Complete Automation Solution

Choose Prodigy and you will be able to standardise on one software package to accommodate all of your requirements. From cost effective data logging through to comprehensive factory wide manufacturing execution system, Prodigy covers all your needs in one scalable and cost effective package. This saves time learning how to use several different software packages, which in turn saves money and makes it easier for you to integrate your business operations.



Developed From Real Applications

Prodigy's success lies in the fact that it has been developed to meet the needs of real world applications. We work very closely with our customers to provide facilities that meet their exact requirements. The result is a software package rich in useful facilities that can be quickly configured to handle a wide range of applications from many industry sectors.



Technically Superior

Prodigy is fast, efficient and has no practical limitations to the size of application it can handle. Prodigy can even run as a Windows Service, allowing it to start work even before anyone has logged on to the system. This is an essential requirement for secure applications in many industries including pharmaceuticals, food processing, hospitals, heat treatment, aerospace, etc.



Only Pay For What You Need

Prodigy is an integrated software product that provides a wide range of facilities. You choose which facilities you need and how many tags your system will require by selecting a license that is tailored to your application. You only pay for what you need. You can buy additional tags or facilities later as the need arises. Unlike many systems, Prodigy's security is not hardware based, which means that upgrades can be purchased anytime and sent immediately via email if required.



Global Standard

Developed in the United Kingdom and first released over 10 years ago, Prodigy has a substantial installed base around the world. Prodigy now sets the standard for industrial automation software by providing a range of facilities and prices, which cannot be matched by competing products.



Dynamic Attributes

Display Builder provides a full range of attributes that can change dynamically as plant values change:

- Size
- Position
- Orientation
- Colour
- Fill level
- Visibility
- Text/Numeric display

Button objects allow operators to:

- Switch displays
- Run reports
- Set signal values
- Display XForms
- Run applications
- Accept alarms

POW

Prodigy Over the Web allows you to view your displays using Internet Explorer from any location on site or around the world.

Administrator controls allow user access to be unrestricted or password protected. For high security applications access may be further restricted by specifying the MAC address of those PC's which are allowed to access Prodigy Over the Web.

Display Builder

Prodigy Display Builder is a graphics package that makes it easy for you to create an operator interface that is simple to use and visually appealing.

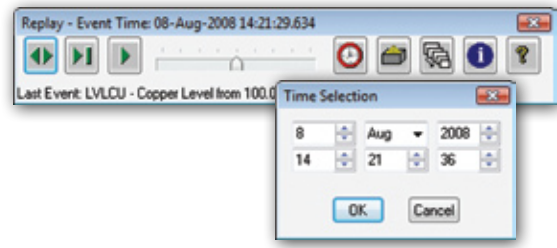

Display Replay

Use DVD style controls to pause, rewind and replay the action from any display. This powerful tool can be used to aid fault diagnosis, perform post-mortem investigations or help with user training.

Touch Screen Support

Larger button sizes, access to right click options and a pop-up numeric keypad are some of the options provided to help with touch screen systems.

Dynamic Attributes

Simply right-click on any object to display its property dialog. A whole range of dynamic properties can be assigned to an object.

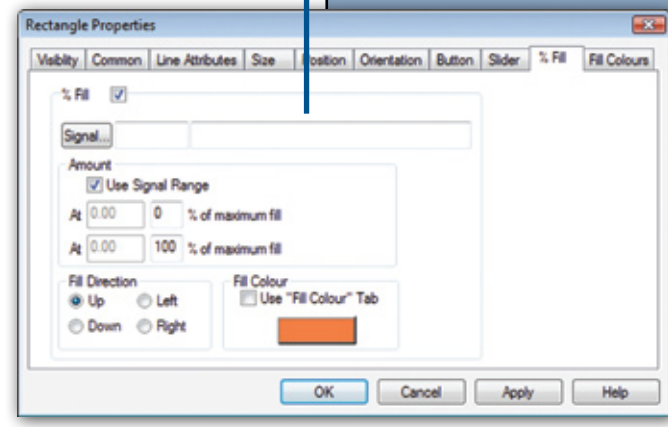

Intelligent Objects

Prodigy provides a range of Intelligent Objects which make it easy to add dials, bar indicators thermographs and sliders that offer a wide range of controls over the object's appearance and animation effects.

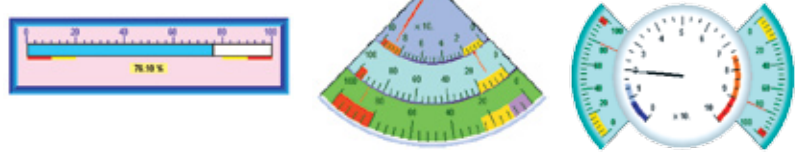

Library

Prodigy Display Builder includes a comprehensive library of plant items that can simply be dropped onto your displays. The library can be extended by adding your own objects, created using Prodigy Display Builder. Library objects can be made into 'Super Objects'. This means that they contain all of the information required to automatically create the signal database entries when they are placed on a display.

Pop Up Displays

Pop Up Displays can be used in several ways. They can provide multiple 'floating' views of your system for ease of use. They can also be linked into other displays to create a section of display which is shared between any number of other displays. By modifying just one Pop Up your changes will propagate to all displays which share the same Pop Up. This will save you time and ensure consistency.

Toolbars

Toolbars are used to provide access to the objects used in creating displays and also to tools that allow objects to be positioned relative to one another. All toolbars may be docked or floated over any part of the display.

Operator Interaction

Your own icons can be made into buttons. They can be configured to display forms, set signal values, switch displays, run reports or launch other programs. Prodigy also provides standard Windows™ buttons including check boxes and radio buttons.

Tool Tips

Tool Tips allow you to provide useful information to guide the operator.

Graphics Support

Display Builder takes full advantage of the latest developments in graphics hardware. Display Builder offers true colour, unlimited screen resolution and support for dual-monitor displays. Powerful gradient fills, transparency effects and animation timers make it easy to produce professional displays very quickly.

Thermal Imaging

Prodigy provides extensive support for the capture of data from thermal line scanners and the representation of this data within Display Builder. This includes realtime and historic false colour thermal images, thermographs, 3D waterfall displays and sector trends

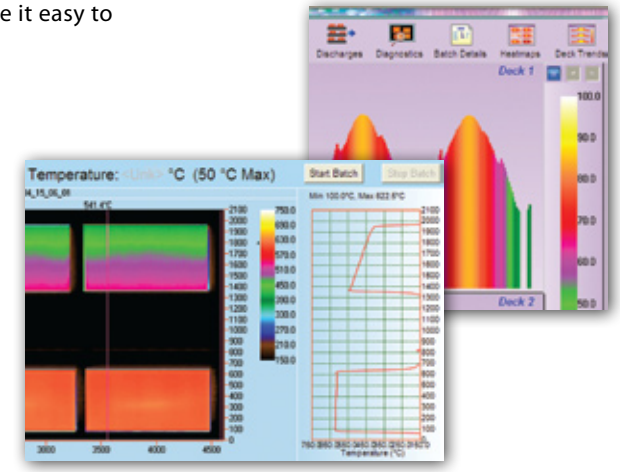

Configuration

Display Builder is used to both design and run the operator interface. There is no need for separate editor programs and the effects of any changes made can be seen instantly by pressing the Go button.

Display Builder is event driven, so objects with dynamic attributes are adjusted only when their associated plant value changes. This reduces processor loading and makes displays fast and responsive.

The ease and speed with which the operator can switch between displays makes Prodigy the fastest display system on the market.

Display Builder is fully integrated with the Trending system so you can switch seamlessly from plant views to trend displays and also include trends within your plant displays.

Enhanced Performance

Prodigy provides facilities to tune the response and appearance of your displays. Adjustable refresh rates allow you to create smoother animation effects without adversely impacting on processor usage. On demand data gathering allows individual displays to query plant I/O for new values at a faster rate than the driver is polling.

Trending

Prodigy includes state of the art trending facilities. Whether you are looking for sub-second detail or a seasonal trend, Prodigy's trend facilities will quickly provide the information you require.

Intelligent Recording

Prodigy implements intelligent recording strategies that are user configurable on a tag by tag basis. These strategies allow Prodigy to capture the maximum signal detail whilst using the minimum storage space. This means that the trend display can handle more data, more quickly.

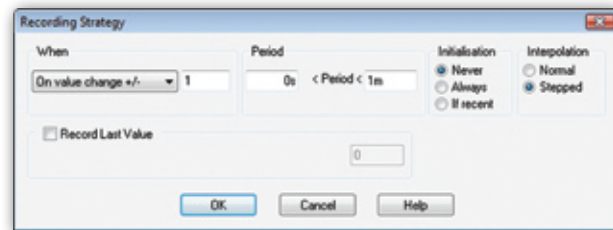

Axis Positioning

Simply click on any axis to move it up or down. This allows you to align your data which makes it easier to compare trends.

Modify "on-the-fly"

Prodigy allows you to modify which tags you see in a trend "on-the-fly". This allows you to quickly view the state of any tag in the system on a one-off basis without having to configure a specific trend.

View Archived Data

Prodigy makes it easy for you to view archived data. Whether the data is on a floppy, CD or hard drive, simply click the button and tell Prodigy trends where to find the data.

Batch Aware

Prodigy trends are "batch aware", which means that they fit seamlessly with the Prodigy Batch Handling facilities. When a batch is selected the trend view is automatically adjusted to frame the time span of the batch. If Tag Aliasing has been used the tags shown in the trend are automatically switched to be those relevant to the selected batch. To make it easy to find the batch you need, Prodigy provides a number of filter options including wild card search and SQL queries.

Live Switching

Prodigy allows you to switch seamlessly between realtime and historical data. Double click on any realtime trend and it instantly switches to the historical view of the same signal values.

Unlimited Time Span

There is no limit to the time span that a Prodigy trend can display. Whether you want to look at a couple of seconds or several years' worth of data on one view, Prodigy will provide the graphs you require. Intelligent recording strategies ensure that display refresh is almost instant which means that you can find the data you are looking for very quickly.

Zoom In Or Out

You can zoom in on any area of interest by simply dragging a cursor box around the relevant part of the trend. Millisecond time stamping allows you to see the finest detail.

Mean or Peak Trends

Prodigy trending incorporates mean and peak mode viewing. Whilst mean is ideal for short to medium time spans, long time spans can tend to become cluttered. With the peak mode, Prodigy draws two trend lines that describe an envelope around the max and min trend values. This keeps the display uncluttered, making it easier to see the underlying trends.

Smoothing

Prodigy trending incorporates fully interactive smoothing of noisy data. Successively increasing the smoothing level can remove spikes from data allowing the underlying trend to show through more clearly.

Statistical Process Control

Gain direct access to Prodigy's SPC facilities for any trended signals that form part of an SPC project.

Data Scrolling

Prodigy trending has a full range of scroll, pan and zoom facilities. The trend window can be scrolled left or right ad infinitum, allowing you to view recorded data from any given time period.

Notes

Operators may record notes at any time via the Prodigy Comments facility. The position in time of these comments can be shown on any trend simply by pressing the "Notes" button. Clicking on a specific note then displays the comment that was entered by the operator.

Dual Trends

Prodigy can display data from two different time periods either side by side or overlaid with the second data set displayed as a 'ghost image'. This provides the ideal way to compare batches or different production runs

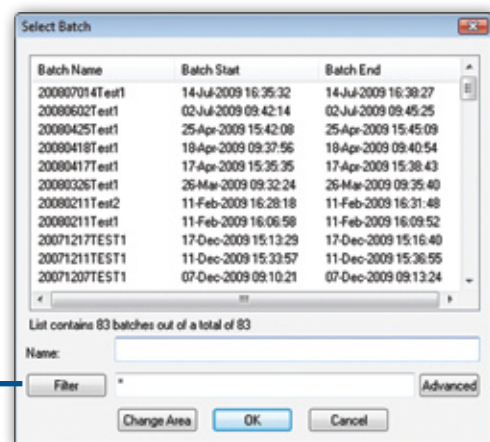
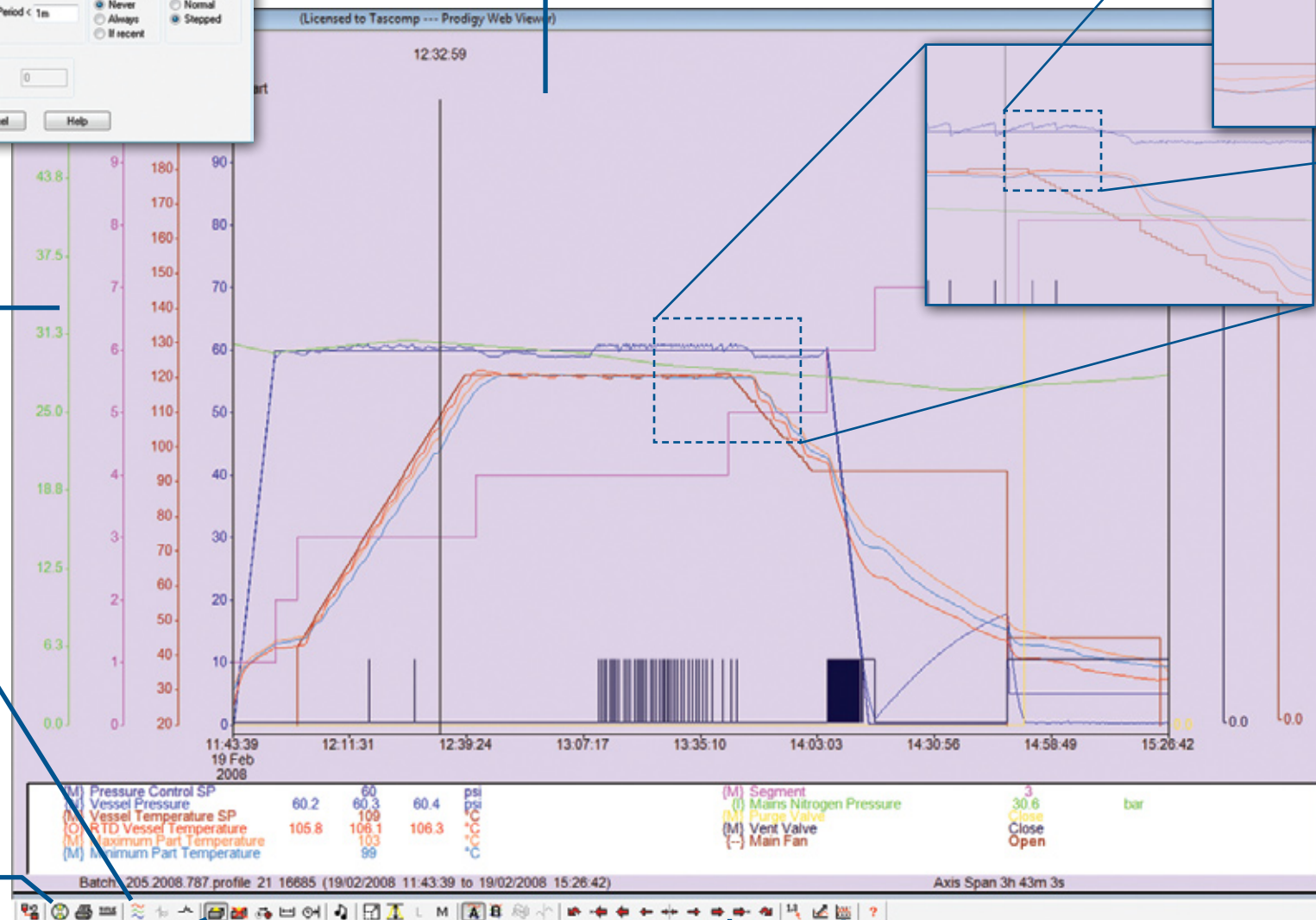

Historic

Unlimited signals per trend display.

Display data over any time period. Prodigy places no restrictions on the amount of data that can be viewed.

Retrieve batch graphs using your own batch names.

Modify trends in realtime, "on-the-fly".

Instantly switch back to realtime view of data.

Vertical cursor allows exact signal values to be read.

Provides seamless access to all recorded data.

Zoom in on areas of interest.

Auto-scale signal ranges "on-the-fly" to improve clarity of small data changes.

Realtime data smoothing.

Supports Control Profiles and Ideal Curves.

View archived data directly from CD or file server.

Supports min, max and average graphing modes.

Alarms

Alarms logged to:

- Alarm history database
- Batch database
- Alarm banner
- Annunciators

Prodigy allows a different annunciator to be chosen for each alarm state and any number of physical annunciators may sound when any given alarm arises.

Alarms can be set to auto-accept when they revert and this can be configured separately for each alarm state.

Alarms can be analysed system wide or on a batch by batch basis and can be filtered on a number of criteria including:

- Alarm type
- Plant area
- Alarm/Event
- Acknowledgement
- Priority

Alarms can be accepted via the on-screen Alarm Banner or via remote access terminals.

Alarm Schedules allow different alarm limits at different times throughout a process run:

- Set a pattern of alarms for different plant conditions
- Enable/Disable alarms in groups
- Automatically change Alarm Schedule depending upon signal conditions

Alarms

Prodigy provides sophisticated alarm monitoring, reporting and logging facilities that enable operators to react quickly to problems arising on the plant and to analyse faults over any given time period.

Prodigy's Alarm Manager monitors the state of all plant values that have alarm limits defined. When an alarm condition occurs the alarm manager notifies all other parts of the system that have an interest in that alarm. This may be an audible siren, a beacon, a printer, an on-screen display and so on. In addition, the alarm is logged to both the continuous and batch alarm databases and to selected Prodigy Alarm banners.

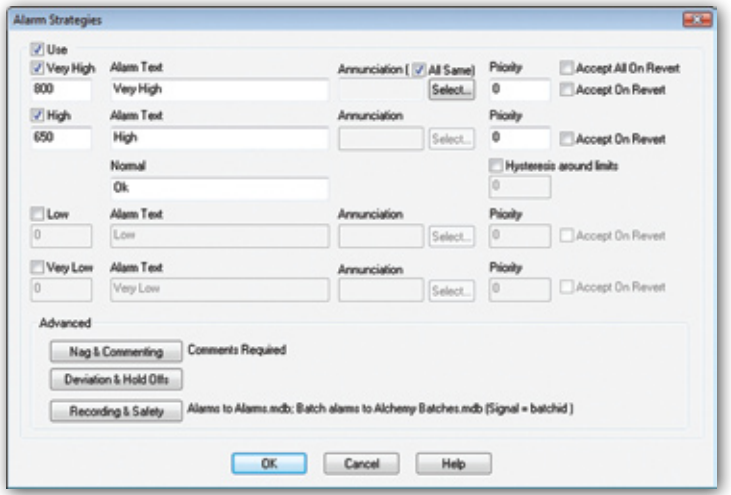

Prodigy allows alarm levels to be set for Very Low, Low, High and Very High, along with descriptive text for each condition. Alarms can be absolute or deviation from set point. In addition, sophisticated tools allow alarms to be applied to such things as the rate of change of a signal value, or on the length of time a signal remains in a given state. Spurious alarms can be minimised by applying alarm hysteresis or marking them as timed alarms, which will only sound when the alarm condition has been exceeded for a specified time period.

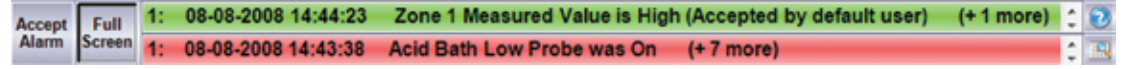

Prodigy's Alarm Banner can be displayed on all or any workstations in a given system. It displays a list of all current alarms sorted either chronologically or in priority order and optionally filtered on criteria such as category, plant area or alarm type.

The operator must use this banner to accept any alarms and if security is implemented they must enter their user ID and password. This prevents unauthorised personnel from accepting alarms.

The Alarm Manager records the following information:-

- The alarm state that has been entered or left.
- The date and time of the change in alarm condition (including alarms being acknowledged).
- The value of the signal at the time the condition altered (including signal values becoming unknown or disabled).
- The name of the operator who accepted the alarm.

Date/Time	Signal	Accepted	By	Description	Text	Comments
08-08-2008 14:43:38	LVLABLO	Accepted	default user	Acid Bath Low Probe was On		
08-08-2008 14:44:10	AA	Accepted	default user	Waiting for operator to enter production details		
08-08-2008 14:44:23	C1MV	Accepted	default user	Zone 1 Measured Value is High		
08-08-2008 14:44:24	C2MV	Accepted	default user	Zone 2 Measured Value is High		
08-08-2008 14:44:25	C3MV	Accepted	default user	Zone 3 Measured Value is High		
08-08-2008 14:44:47	VALVE2AL	Accepted	default user	Valve 2 Maintenance is Overdue		
08-08-2008 14:44:49	PUMP1AL	Accepted	default user	Pump 1 Maintenance is Overdue		
08-08-2008 14:44:54	VALVE2AL	Accepted	default user	Valve 2 Maintenance is Overdue		

As well as alarms, the Prodigy Alarm Manager also caters for Events. These are information messages generated by for example, control programs. These messages are displayed, logged and accepted in the same way as alarms. In addition they may be set up to appear for a fixed length of time before being removed automatically.

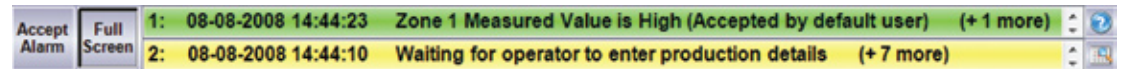

Sometimes different alarm limits need to be applied at different times throughout a process, and at other times the alarms may need to be disabled altogether perhaps during a plant startup or shutdown period. Prodigy uses **Alarm Schedules** to cover these situations. Any number of alarm schedules can be created and Prodigy can be programmed to automatically swap between these different schedules at any time throughout a process run.

SMS & Email Facilities

Prodigy provides a number of ways to keep in touch with your business using your mobile phone or email access.



SMS1 - Alarm Output

SMS1 provides a way of distributing alarm messages to mobile phone users. Each user registers their mobile number with Prodigy and joins one or more alarm groups. They will then receive an SMS text message for each alarm that occurs, clears or is accepted. SMS1 works using any standard telephone line and modem by sending the alarm messages via your selected message centre.

SMS2 - Interactive

SMS2 provides a fully interactive alarm facility. Users may receive and accept alarms using their mobile phone. You can request signal values to obtain up to the minute information directly from any Prodigy system. For commonly required items of information, any number of mini reports can be configured and sent directly to your mobile phone at any time. Users may also log on or log off from the service using their mobile phone.

Email Alarms and Reports

All of the alarm and report facilities provided by SMS2 can also be accessed via email. This not only allows you to receive alarms, accept alarms, log on/off and receive signal values, it even allows you to receive process graphs and reports either on demand or as an accompaniment to the alarm messages.

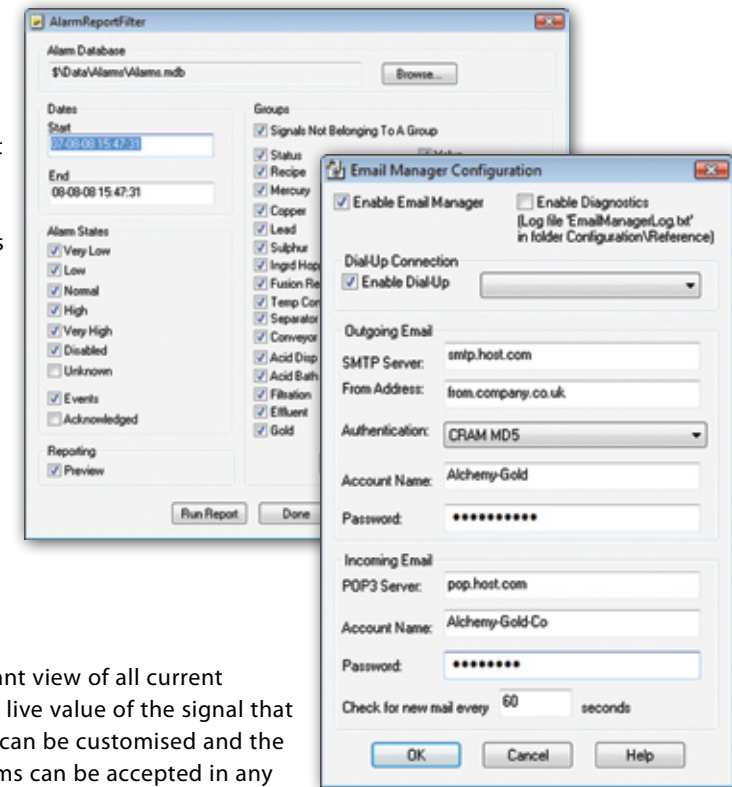

Alarm Display

The alarm display provides an instant view of all current alarms, their alarm priority and the live value of the signal that is in alarm. The columns displayed can be customised and the alarms sorted on any column. Alarms can be accepted in any order or accepted by group or priority etc. Alarm acceptance can be configured to require an operator comment to be entered before acceptance takes place.

Date/Time	Tag	Text	Pr...	Trigge...	Curren...	Groups	Accept...	Accepted ...	Re
08-08-2008 14:43:38	LVLABLO	Acid Bath Low Probe was On	0	0	0	Status, Acid Bath			14:4
08-08-2008 14:44:10	AA	Waiting for operator to enter production details	0			<Link> None			
08-08-2008 14:44:23	C1MV	Zone 1 Measured Value is High	0	664.38	707.14	Fusion React, Temp Control	default user	14:45:54	14:4
08-08-2008 14:44:24	C2MV	Zone 2 Measured Value is High	0	777.49	707.14	Fusion React, Temp Control			14:4
08-08-2008 14:44:25	C3MV	Zone 3 Measured Value is High	0	654.17	704.28	Fusion React, Temp Control			14:4
08-08-2008 14:44:47	VALVE2AL	Valve 2 Maintenance is Overdue	0	1	1	Acid Disp, Valve			
08-08-2008 14:44:49	PUMP1AL	Pump 1 Maintenance is Overdue	0	1	1	Ingrd Hopper, Pump	default user	14:45:50	
08-08-2008 14:44:54	VALVE2AL	Valve 2 Maintenance is Overdue	0	1	1	Copper, Valve			

Alarms

SMS1

Receive alarm notification on your mobile phone.

Any number of recipients.

Arrange alarms into user groups.

Log on/off by user or group.

Uses standard modem.

SMS alarm indicates:

- Plant area
- Alarm date
- Alarm time
- Alarm condition
- Current measurement

SMS2

As SMS1 plus:

Accept alarms from your mobile phone.

Receive mini reports.

Log on.

Log off.

Secure alarm acceptance.

Built in command help.

Uses GSM modem.

No land line required.

Email alarms

Distribute alarms to any email address.

Include graphs with each alarm report.

Accept alarm via email reply.

Receive event messages.

Request process reports.

Recipes

Data held in Microsoft Access or SQL Server™ format.

Any number of recipes can be created.

Use recipes to set values in PLCs etc.

Recipe data stored as part of batch history.

Free form design allows electronic recipes to emulate existing manual recipes.

Recipe & Batch Facilities

Prodigy includes comprehensive support for batch and recipe handling including form-filling, automatic batch creation & monitoring and Proof-of-Process reporting.

Recipes

Recipe data is a collection of control setpoints that define the parameters required to make a specific product or control a specific process. Prodigy allows any number of such recipes to be created and called up via user defined forms.

These forms may display the recipe data and optionally allow items to be modified. They may also allow additional data to be entered that does not form part of the recipe but which may be required as part of the batch history.

Data entered via a form may be written to any or all of the following:

- Recipe Database, for the selected recipe.
- Batch Database, for the selected batch.
- Signal database, to be used as setpoints etc.

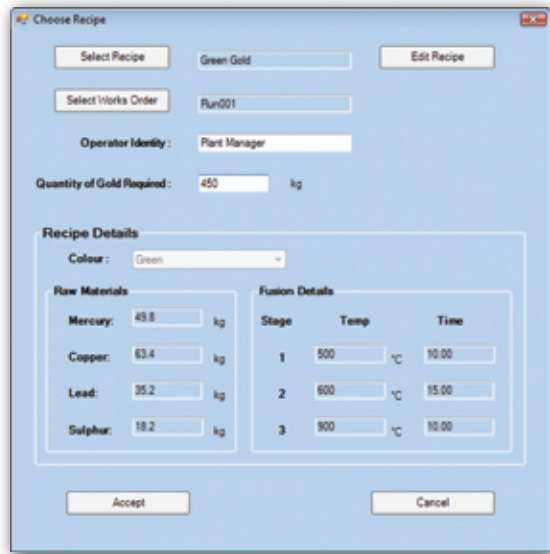

XForm

Prodigy provides a powerful screen based form creation tool called XForm. These full colour forms can incorporate alpha/numeric information, images and even live data. Fields on each form may be linked to the Recipe Database, Batch Database and real-time Signal Database. Data validation tools can be configured to check operator entries and flag inconsistent or erroneous data. Links to Prodigy's Slang programming environment allow the creation of 'wizard' forms to guide the operator through the data entry process. XForm lies at the heart of Prodigy's Batch and Recipe facilities.

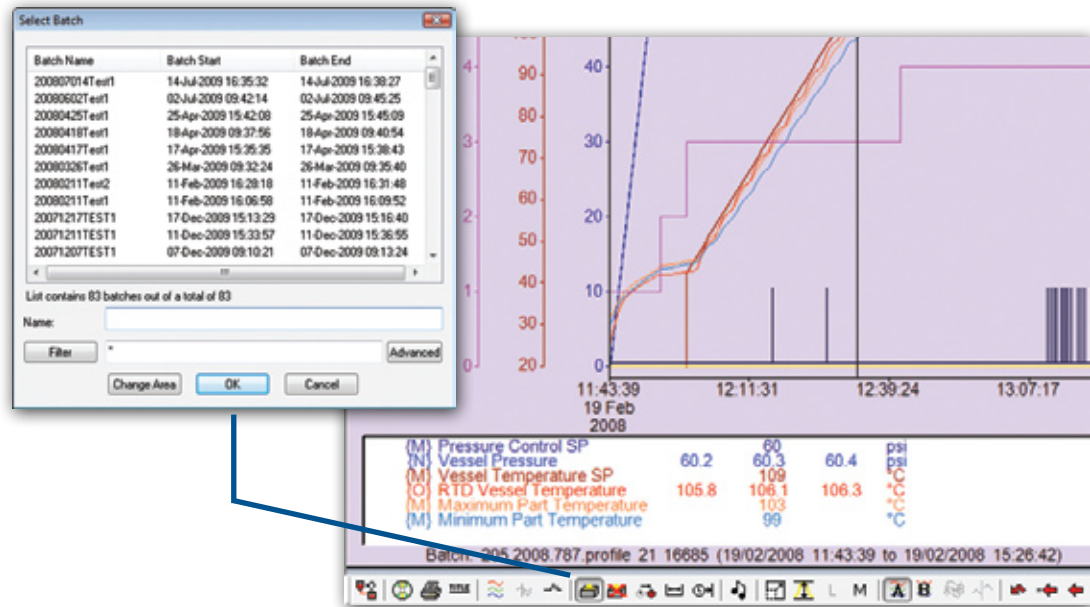

Batch Based Trending

All relevant parts of Prodigy are "batch aware". For instance, batches can be accessed from within historical trends where the start and end dates shown on the trend will be taken from the batch that has been selected.

Prodigy's tag substitution facility means that the same trend can be used to show data from different batches, even if those batches relate to different parts of the plant. For example, if you have 20 different production lines you can configure one trend to look at the data from any one of these lines, rather than having to configure up 20 different trends. This facility also applies to trends shown in the single page Proof-of-Process reports.

Batch Data Recorder

Prodigy's Batch Data Recorder makes it easy to handle the requirements of a batch based process without the need to write programs or configuration scripts.

BDR works by monitoring the system and watching for the occurrence of any of the criteria that have been defined as meaning that a batch is beginning. This may be something simple such as a digital signal going high or a complex set of conditions that must all be satisfied before the batch can commence.

When the batch begins, BDR can reset selected signals and also store the current value of any number of signals into the batch database.

As the batch progresses, the values of any number of signals may be periodically written into the database, to keep a working record of how the batch is progressing.

A batch ends when the conditions defining the end of the batch become true, such as a digital going low, or a given expression evaluating to true. Again, data may be written to the database and signal values reset when the batch ends. Prodigy can also perform statistical surveys, calculating items such as mean, max, min, standard deviation, runtime, number of operations etc.

Batch Reporting

Proof-of-Process reports may be generated automatically by Batch Data Recorder when a batch ends. They may also be called up manually at any time. These reports, which are user configurable, can display:

One-off batch data such as Operator ID, batch run time, materials used, total product made, etc.

A list of all of the alarms that occurred during the batch.

Any number of trends each showing any number of signals.

If there is too much data to display neatly on one batch report, Batch Data Recorder can be configured to run as many different reports as required when a batch ends, so you can divide your reports up into appropriate subsections of the batch process.

Batches

Batches can be created manually or automatically.

Facilities to continue an existing batch or start afresh.

Any number of batches may be created.

Full reporting, including multi-batch reporting.

Data available to third party reporting software.

Alarms recorded to batch database.

All relevant features within Prodigy (e.g. trending, SPC) are batch aware.

Single page "Proof-of-Process" reports automatically generated on completion of batch.

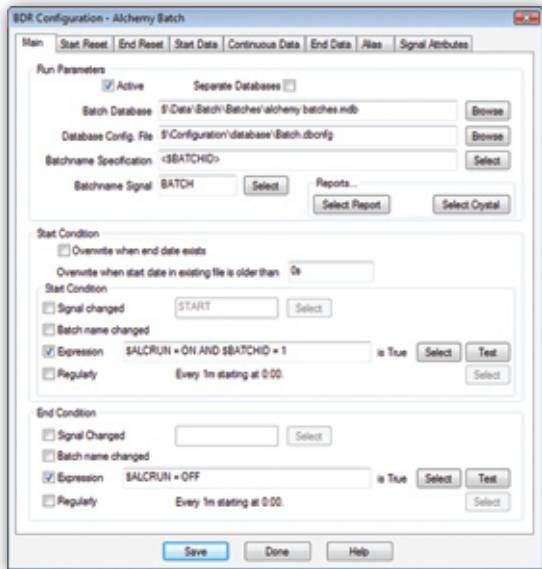

Access to Prodigy and standard desktop applications via a configurable menu bar.

Simple password or sophisticated privilege based security systems.

Security may be applied to any item that requires input from the operator, thus preventing unauthorised access of such things as accepting alarms through changing setpoints to reconfiguring the database.

Security log shows who did what and when.

Multi-level menus allow facilities to be grouped into logical areas.

User defined privileges.

User Access & Security

Prodigy makes it easy for the user to find the facilities they need. Its configurable menu system provides direct and secure access not only to Prodigy facilities but also to other Windows™ applications.

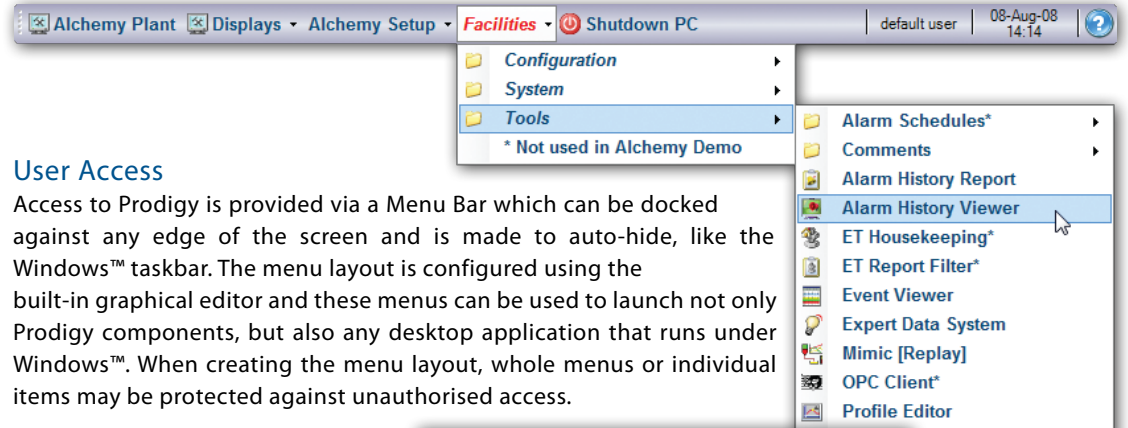

User Access

Access to Prodigy is provided via a Menu Bar which can be docked against any edge of the screen and is made to auto-hide, like the Windows™ taskbar. The menu layout is configured using the built-in graphical editor and these menus can be used to launch not only Prodigy components, but also any desktop application that runs under Windows™. When creating the menu layout, whole menus or individual items may be protected against unauthorised access.

Security

Prodigy provides two types of security:

- A simple password, which everyone who wishes to access this item must know.
- A privilege based system whereby individual users may be assigned a range of privileges to allow them access to particular aspects of the system.

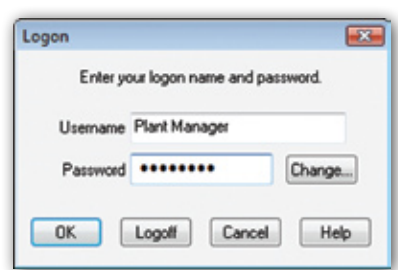
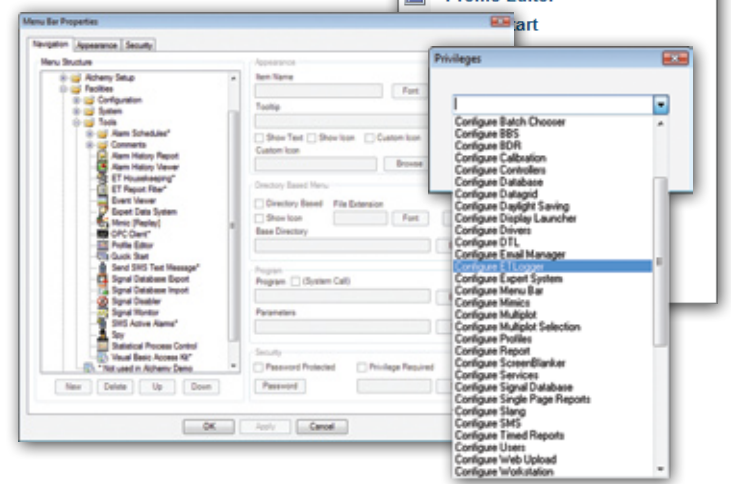

Operators may log on to the Prodigy system to gain instant access to the features for which they hold privileges. Alternatively, they may enter their user ID and password each time they access a feature for which the current user is not privileged.

Prodigy supports the idea of a "Default User" which may be enabled with a limited set of privileges, perhaps providing "view only" access to the system. In the absence of any other user being logged in, it is the privileges assigned to the default user that are applied.

Prodigy comes with a set of standard privileges that can be used to restrict access to certain facilities. It also allows you to create your own privilege types to provide further access limitations as required.

The user database can also hold a mobile phone number and email address for each user, which will be used to send alarms and reports to user phones or PCs using Prodigy's SMS text message and email facilities.

Prodigy's security mechanisms have been specifically designed to meet the requirements of standards such as FDA 21 CFR Pt 11, and GAMP, which are covered on page 16 of this brochure.

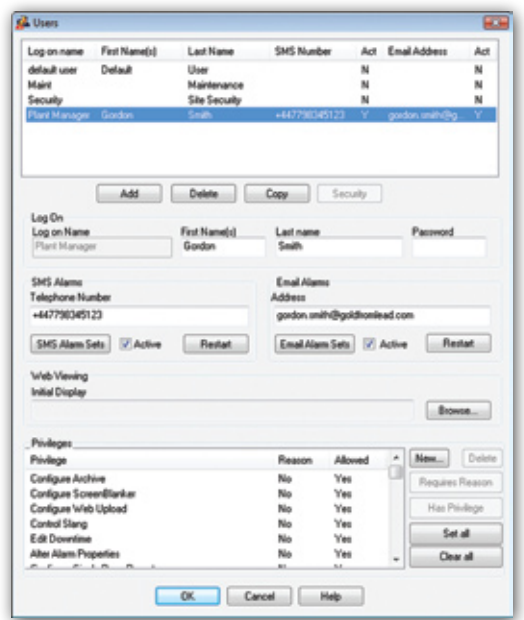

Online Maintenance

Prodigy's Online Maintenance and support facilities provide quick access to vital information to reduce downtime, improve efficiency and reduce operating costs.

Information Retrieval

Prodigy's Online Maintenance provides a single source of support information for operators and maintenance engineers. It allows them to access standard operating procedures, routine maintenance instructions, machine schematics, emergency contact numbers or procedures, maintenance videos and much more. All of the information which is usually 'filed away... somewhere!' can be kept in one location, properly indexed and ready for rapid access when required.

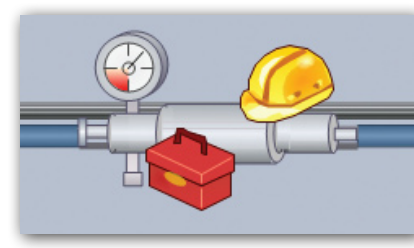
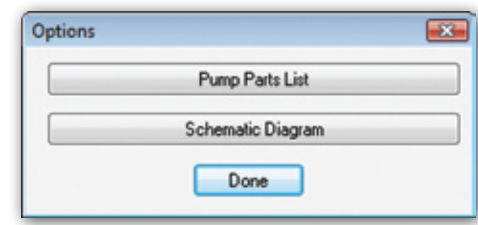

Quick Access

To make it easy to find the information required to help solve a particular problem, Prodigy allows any number of 'maintenance icons' to be placed on the plant displays, next to the item of equipment to which they refer. These icons can be hidden from view in normal operation, automatically appearing when Prodigy detects a problem such as a specific alarm condition or incorrect sequence of events.

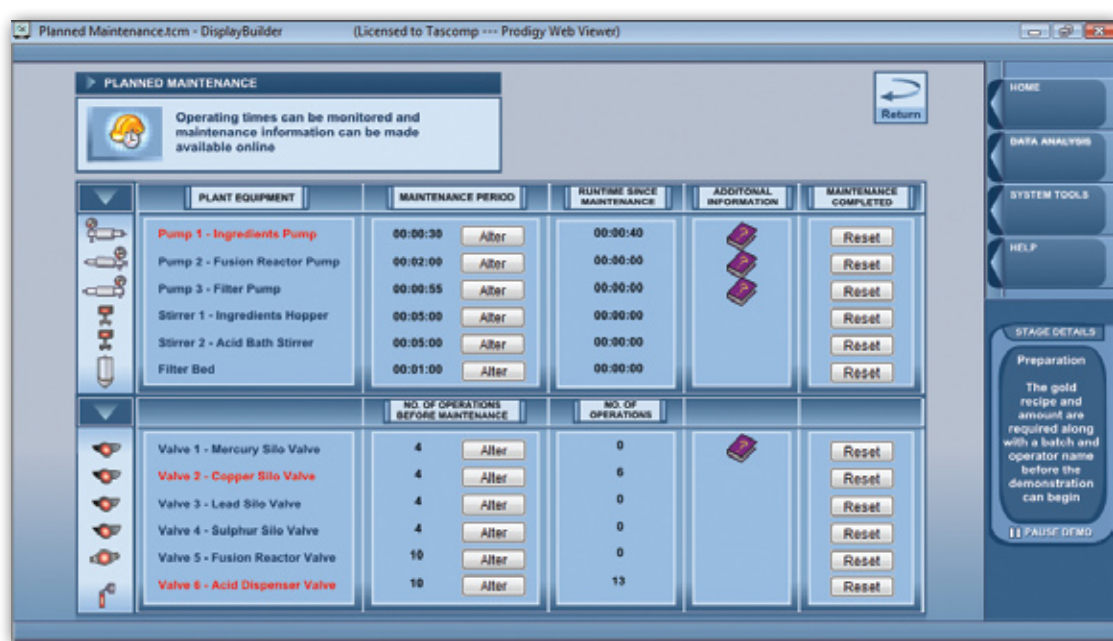

To help with the timing of routine maintenance, Prodigy can monitor a wide range of parameters that effect the maintenance intervals. These can include run times, number of operations/cycles, time spent under load, total throughput etc. Prodigy then provides messages to indicate that scheduled maintenance is imminent or overdue. It will even pop up the maintenance icon on the plant display next to the item of equipment that requires maintenance.

Calibration Tracking

Prodigy's calibration tools walk the engineer through the calibration process. To save time, it allows multiple channels to be calibrated in one pass. Prodigy keeps track of the calibration settings which are stored into the calibration tracking database along with the date and engineer identity. Calibration reports provide vital proof of calibration and allow transducer drift to be monitored.



All common file formats supported:

- JPG
- BMP
- AVI
- MPG
- WAV
- Plain text
- Rich text
- Word™
- PDF

Instant access to maintenance information.

Automatic display of maintenance icons.

Routine maintenance scheduling.

Reporting

User configurable reports via Prodigy's intuitive Easy Report software.

Proof-of-Process reports with automatic link to batch handling.

Batch reports.

Historic Alarm reports.

Data format:

- Microsoft Access™
- SQL Server™

SQL filtering.

Report options:

- Timed reports
- Faxed reports
- Email reports
- SMS text reports
- PDF reports

Reporting

Printed reports provide a convenient way of sharing and understanding detailed information. Prodigy provides comprehensive facilities that allow you to combine text, graphics and trends to help make complex information easy to understand.

Prodigy can store information in both Microsoft Access™ and SQL Server™ format. This allows you to use any compatible software to analyse your data and prepare reports that are laid out exactly as you need them. Prodigy also provides three powerful reporting tools which are fully integrated with Prodigy to make them easy to use:

- Easy Report – comprehensive tabular & graphical reports without the hassle
- Proof-of-Process Reports – concise reports for batch based processes and validated systems
- Multigraph – analytical reporting for development environments

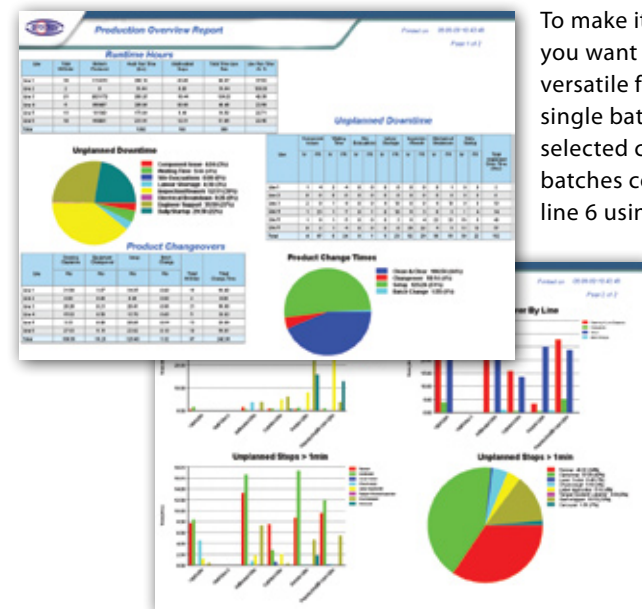

To make it easy for you to select the information you want to include on a report, Prodigy provides a versatile file/batch selector. This allows you to select a single batch or perhaps a range of batches that match selected criteria. For instance, you could specify all batches covering the month of July that were run on line 6 using raw material xyz.

This filter mechanism can even include SQL (Structured Query Language) enquiries for added flexibility. Prodigy then scans the batch database, selects those records that match the selection criteria and passes them on to the report generation software.

Easy Report

Tabular reports, pie charts and graphs make complex information easier to understand and share. Easy Report provides all the tools you will need to create professional looking reports quickly and easily. Simple layout tools allow you to place text, graphics, drawings, tables, pie charts, etc. freely on the page. Data for these items can be sourced directly from both Microsoft Access™ and SQL Server™ databases without the need to pre-process the data.

When adding tabular data, Easy Report automatically aligns columns with titles, flows the data between pages, paginates, highlights out of range values and calculates totals and derived values to simplify the process wherever possible.

Automatic and Timed Reports

You can configure Prodigy to generate printed reports automatically. Prodigy's Batch Data Recorder (BDR) allows you to specify reports that are automatically generated at the end of a batch. It allows you full control over the format of the report and the destination printer/file. Prodigy can also be configured to automatically generate reports at pre-defined times. For instance shift, daily or monthly reports can be pre programmed and printed automatically as soon as the time period elapses. This saves time and guarantees reliable report generation.

Email, Web and SMS Text Reports

By entering a destination email address it is easy to provide reports directly to specific users via their email account. Prodigy's Web Upload facility can even send reports automatically to a company intranet or external internet web site for global access. For users that are often on the move, Prodigy can be configured to provide mini reports to mobile phones using SMS text messages.



Multigraph

Designed for development environments and end of line test systems, Multigraph provides a flexible way to view multiple data sets against time or as a plot of one variable against another.

Multigraph

Multigraph uses simple drawing tools that allow you to create any number of X/Y axes with exactly the layout you require, giving total flexibility over the way your data is presented. Data points can be automatically sorted and filtered and the graphs can be augmented with annotation or one-off header information as required. Over-plotting offsets make it easy to present several data sets on one report with the header information, position, line types and line colours etc. automatically adjusting for each over-plot.

Report Generation

Producing complex reports covering several data sets is no longer a time consuming task. The powerful data sorting and filtering options in Multigraph make it possible to submit any number of data sets to a pre-defined report layout and generate the required report without any manual data manipulation. Multigraph is ideal for product development or end of line test systems.

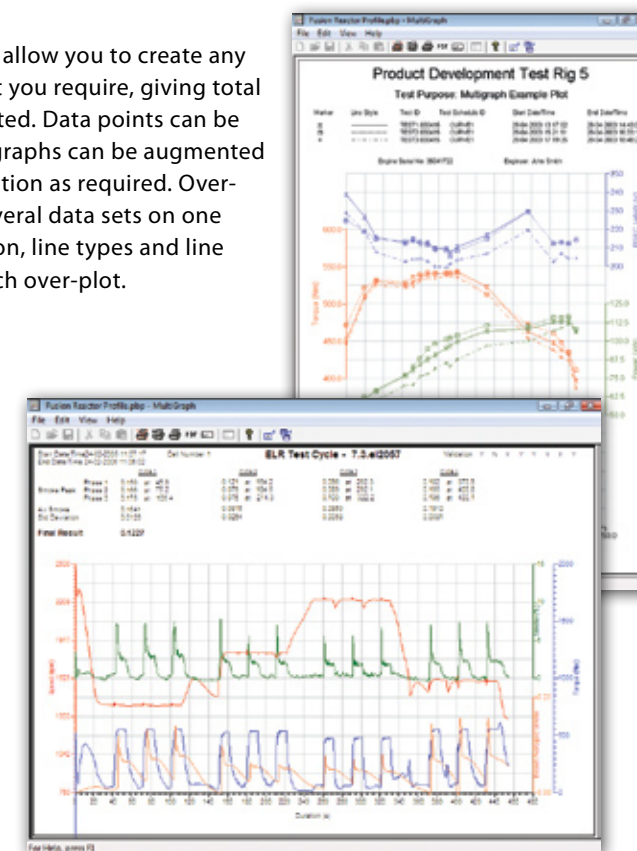

Proof-of-Process Reports

Combining one off process information, alarms, events and process graphs, Prodigy's Proof-of-Process reports provide the ideal process record on a single page.

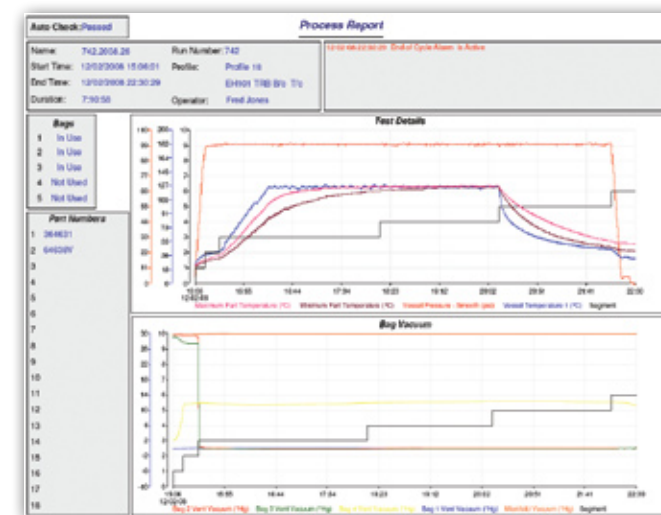

Many manufacturing operations require Proof-of-Process reports before their products can be released. This is especially true in the food, aerospace and pharmaceutical industries. Traditionally, they take the form of several sheets of paper collected from different parts of the manufacturing process, which are clipped together and archived. Prodigy's Proof-of-Process reports provide a much more efficient solution. They combine alarm histories with one-off batch details and any number of process trends into a neat single page report that provides a permanent Proof-of-Process record. They are very easy to configure, which allows them to be kept up-to date with the requirements of the process. Storage of Proof-of-Process reports in PDF format is now becoming the industry standard for long term record storage.

Multigraph

- Automatic over-plots
- SQL data filters
- X/Y point sorting
- Flexible graph layout
- Automated reporting
- Versatile mark styles

Proof-of-Process Reports

Combine three key types of process information:

- Trend graphs
- Alarms
- Process details

Ideal for food processing, aerospace and pharmaceutical.

Proof-of-Process Reports

Many manufacturing operations require Proof-of-Process reports before their products can be released. This is especially true in the food, aerospace and pharmaceutical industries. Traditionally, they take the form of several sheets of paper collected from different parts of the manufacturing process, which are clipped together and archived. Prodigy's Proof-of-Process reports provide a much more efficient solution. They combine alarm histories with one-off batch details and any number of process trends into a neat single page report that provides a permanent Proof-of-Process record. They are very easy to configure, which allows them to be kept up-to date with the requirements of the process. Storage of Proof-of-Process reports in PDF format is now becoming the industry standard for long term record storage.

FDA 21 CFR Part 11 Compliance

To meet the requirements of the FDA 21 CFR Part 11 document for Electronic Records and Signatures, simply tick the box and let Prodigy do the rest.

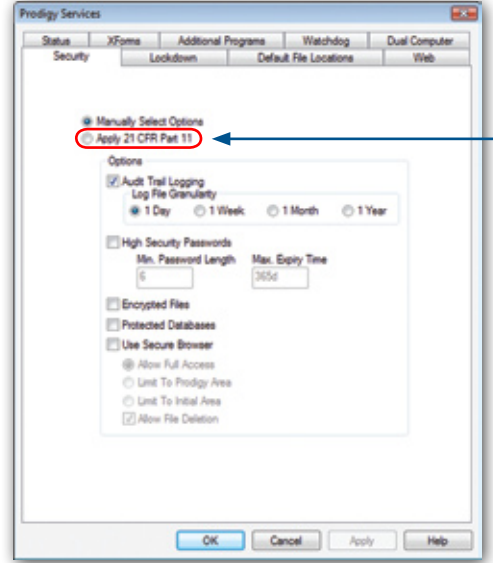

Compliance Made Simple
With complex Windows PC applications it is often difficult and time consuming to validate the finished system to ensure compliance with FDA 21 CFR Part 11, GAMP, GLP, etc. With Prodigy, user security, data security and audit trails are all built in. Each security element can be individually configured, or, by ticking a single check box Prodigy will automatically configure the entire application to comply with the mandatory regulatory requirements.

Audit Trail

Once enabled the audit trail facility will generate a time stamped record of every user action that makes a material change to the system. This includes all of the following:

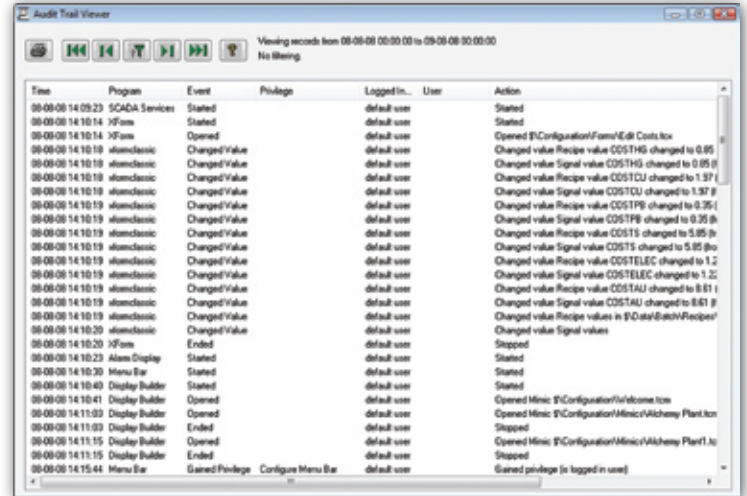

- User log on
- User log off
- Manual signal value changes
- Configuration changes
- Alarm acceptance
- Recipe changes
- System startup/shutdown
- Invalid user access
- Password changes
- User lockout
- Display changes
- Program execution

User Security

To prevent system access by unauthorised users Prodigy implements a user database which allows each user to be assigned a unique user ID, password and list of allowed actions or privileges. User passwords can be forced to a minimum length and to expire at regular intervals. User access is recorded as part of the audit trail and repeated invalid access will automatically invalidate that user's account. The system can also automatically log off an inactive user to prevent the system being left open inadvertently.

Data Security

Prodigy employs strong 128 bit file encryption for all internal data and configuration files. No commercial software package exists that will allow data in these files to be decrypted or tampered with. Industry standard file formats such as Microsoft Access databases are securely password protected in such a way that no human knows the password and only Prodigy may open and present the data enclosed.

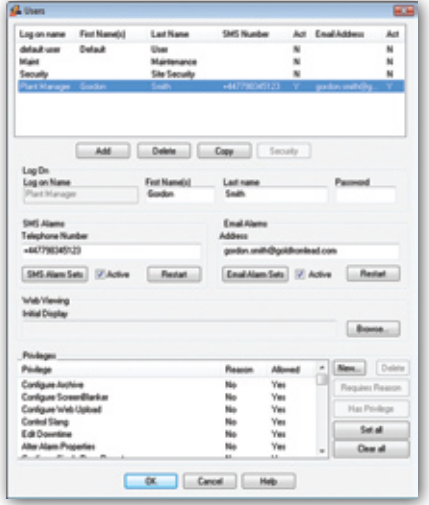

- Comprehensive
- Security encrypted
- Audit reporting
- Audit analysis
- Automatic archive

User Security

- Unique user I.D.
- Password expiry
- Enforced password length
- Operator comments
- Timed operator logout
- Auto lockout on tamper
- User barring
- User access log

Data Security

- 128 bit data encryption
- No commercial decryption tools

Statistical Process Control is now widely used in a whole range of industry sectors and is seen as an essential tool for improving product quality and process efficiency. Prodigy includes a range of fully integrated SPC analysis tools that can quickly bring the benefits of SPC to any process.

Prodigy's SPC facility links directly to the recorded data used for producing trends. This means that the data does not have to be manually collected and entered. A manual entry option is still available however, for data that is difficult to measure automatically, or which is subjective.

Data can be analysed continuously or on a run-by-run basis, perhaps relating to batches or production shifts. Prodigy SPC contains a full range of charting options, including Individual & Range, Average & Range, Median & Range, Line Plots and Distribution Histograms.

Prodigy allows you to swap between the different charts at the click of a button with no need to resample data.

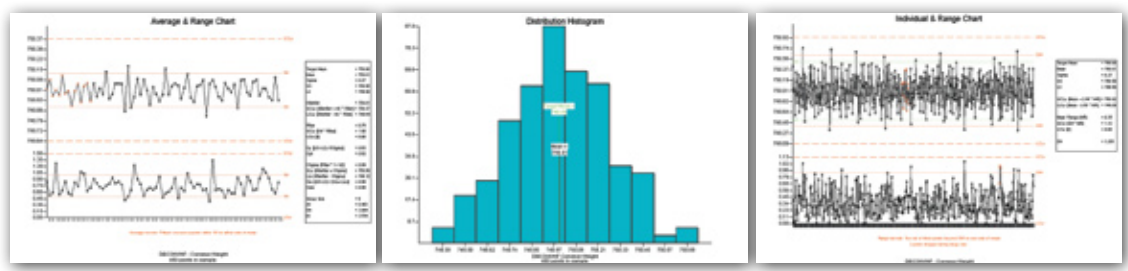

As an integral part of the SPC charts, Prodigy highlights any out-of-control points, indicating whether these were caused by exceeding control limits or by violating pattern rules. Where appropriate, Prodigy can calculate the process and machine capability factors ($C_p/C_{pk}/C_m/C_{mk}$).

As a full aid to the QA process, Prodigy can show the control limits that it calculates for each chart, along with the various constants and working factors that it uses in its calculations.

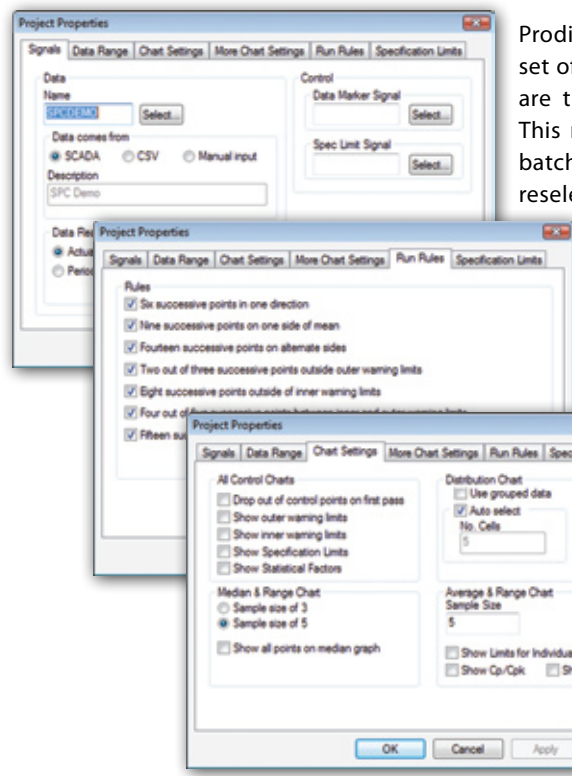

Prodigy SPC is fully configurable allowing a standard set of options to be selected for each SPC project. These are then applied to each SPC run within this project. This means that running an SPC analysis for successive batches of data is as simple as can be with no need to reselect any options.

Standard options include which pattern rules to implement, how to deal with rogue out-of-control points, sample sizes, specification limits, which factors to display and standard options such as line colours and fonts.

As part of the mechanism to allow the automatic capture of SPC data, Prodigy allows you to use plant signals to govern the collection of SPC data. No data will be used for periods where these signals dictate otherwise. For instance, a process may need time to reach operating conditions before any product being created is actually of use. Prodigy SPC can be configured to ignore such periods and only use the data when the process is correctly running.

SPC is integrated with Prodigy's trending facilities. This means that when viewing any historic trend you can switch straight to an SPC analysis at the click of a button. SPC will analyse all signals on the trend for the time period covered by that trend.

Comprehensive range of SPC charts.

Automatic collection of signal data to use in SPC analysis, featuring automatic exclusion of data produced during process runup or pausing.

Calculation and display of all essential factors used in the production of the SPC charts.

- Mean
- Standard deviation
- Process capability (C_p and C_{pk})
- Machine capability (C_m and C_{mk})
- Limits for individuals
- All control limits
- All SPC constants used in the calculations

Automatic application of pattern rules.

Automatic detection and removal of infrequent "rogue" data points.

Direct link to SPC from Prodigy trends enables you to instantly run an SPC analysis for any trend that is being viewed.

Concise, easy to understand programming language.

Simple instruction set:

- Comments
- Go-to a label
- Set an analogue signal or variable value
- Turn a digital signal or variable on or off
- Lock or unlock a variable allows implementation of mutual exclusion
- Wait either for a length of time or until an expression is true
- If-Else-Endif blocks
- Repeat either a number of times or until an expression is true
- Call a Subroutine
- Stop or Start another Slang program

Powerful, extendable function library

Slang

Prodigy provides a powerful yet simple to use Sequence LANGUAGE (Slang) that allows you to quickly develop control programs to tackle the special requirements of your application.

Programming Environment

The Slang Editor ensures your programs are syntactically correct by checking each statement as it is entered. All statements that form a block (e.g. If-Else-Endif) are automatically indented and terminated, expressions are checked as you enter them, variables are checked for scope and existence and so on. It is impossible to create a program that is not syntactically correct, leaving you free to concentrate on the logic.

Program Browser

Slang programs can all run concurrently and one Slang program can start or stop another. You can rapidly switch between the Slang programs you are working on by using the built in browser tree. As well as listing all of the programs, the browser also shows the local variables used by that program and the global variables used by all programs.

Colour Coded Printout

Slang allows you to print out a program listing to a colour printer and have statement types colour coded. This makes it easy to spot comments or statements that perform path switching or statements that set variables and so on. These printouts can form an essential part of the documentation for a system.

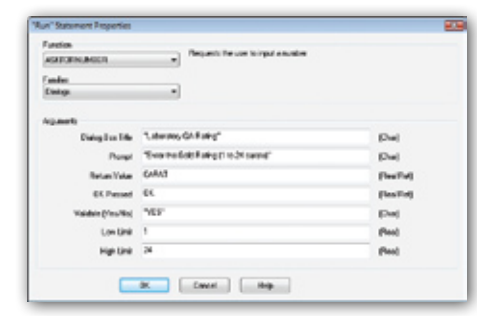
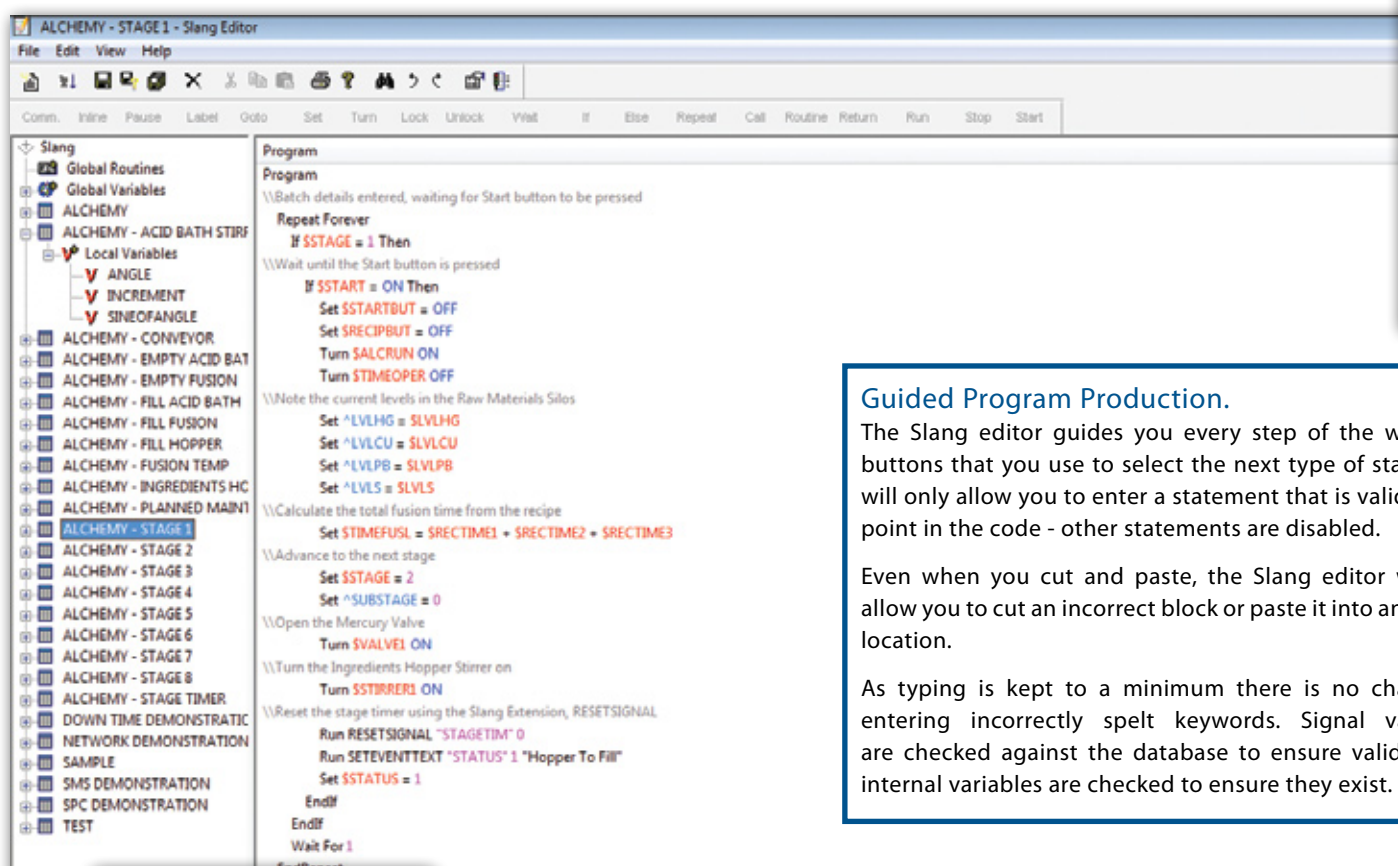

Function Library

Slang contains a powerful function library that allows you to access other parts of Prodigy, display dialog boxes, perform mathematical functions, etc. This library is constantly being expanded and like the rest of Slang, the user is guided through the use of each function in the library, minimising the learning curve.

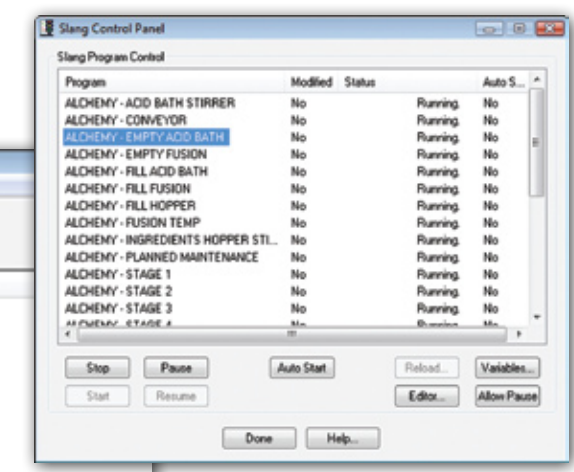

Guided Program Production.

The Slang editor guides you every step of the way. The buttons that you use to select the next type of statement will only allow you to enter a statement that is valid at this point in the code - other statements are disabled.

Even when you cut and paste, the Slang editor will not allow you to cut an incorrect block or paste it into an invalid location.

As typing is kept to a minimum there is no chance of entering incorrectly spelt keywords. Signal variables are checked against the database to ensure validity and internal variables are checked to ensure they exist.

Monitoring

The Slang Control Panel allows you to view, in realtime, the status of all variables used in a particular program. It also allows you to trace the execution path taken by the program which makes it easy to locate logic errors.

Program Control

The Slang Control Panel lets you look at the status of all Slang programs, as well as giving you the option of stopping or starting individual programs. When the Slang Editor modifies a program, it is not automatically run by the Slang Runtime system - it may not be complete. The Slang Runtime system will continue to use the old version of the program until instructed to Reload the modified program.

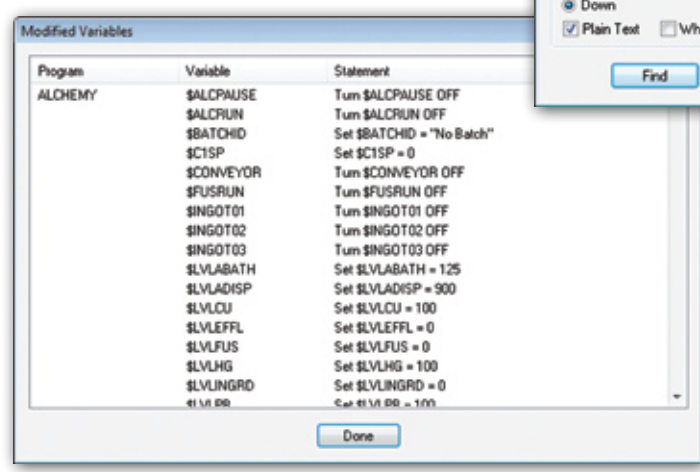
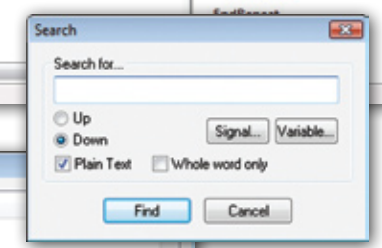

Tracking Variable Usage

Slang Editor makes it easy to keep track of which variables have been used and where. The Find option finds each use of a variable across all Slang programs while Show Modified lists every use of a given variable by a statement that could modify its value. This is especially useful in checking the interaction between various Slang code modules.

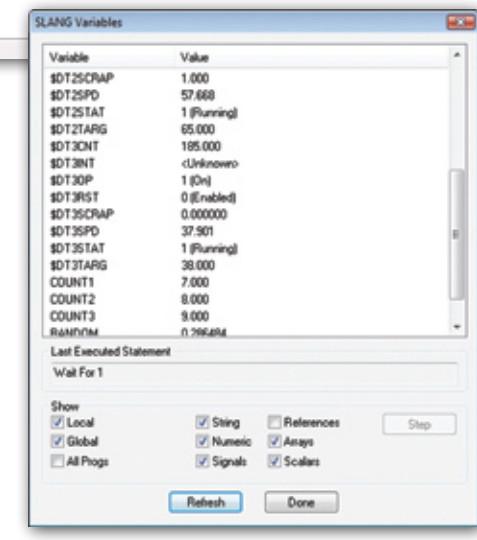

Modularity & Reuseability

A key factor in the development of large systems is code reuseability. It is not only wasteful to have the same program logic again and again. Repeating the same code in different programs is both tedious and error-prone. Global Routines allow common logic to be created then called from any number of programs. Include files allow common code to be included "inline" into a program as if it were actually part of that code. Coding changes to common logic need now only be made once.

Any number of Slang programs can run concurrently.

Individual programs can be started or stopped as required, by other Slang programs or via the Slang control panel.

Monitor the state of any signals and variables used by individual programs.

Colour coded printout for documentation and troubleshooting purposes.

Editor enforces correct program syntax, minimising development time.

Automatic checking of signal and variable usage to minimise errors.

Controllers

Software PID controllers offering full range of facilities:

- Auto-tune
- Direct/Reverse acting
- Analogue/Digital control
- Bumpless transfer
- PID terms dialled in or taken from signals
- Controller variables available to Prodigy trending
- Cascade control

Access to industry standard hardware controllers.

Library of controller faceplates to use in Prodigy displays.

Automatic Test Sequence

- Spreadsheet schedule entry.
- Unlimited test schedules.
- Unlimited test phases.
- Up to 250 control variables

- Ramp rate
- Set point
- Dwell
- Hold-off

- Conditional phase termination.
- Repeat loops.
- Conditional branching.
- Ideal for multi-loop profile control.

Controllers

Prodigy communicates with a wide range of three-term (PID) controllers and also implements its own controllers in software. These provide a low cost alternative to hardware controllers and allow greater flexibility in configuration and use.

Prodigy's software controllers implement all the functionality of a hardware controller, including auto-tune, direct or reverse acting, digital control and "bumpless transfer".

Any number of software controllers can be configured. Each one can have PID terms that are either entered via the Software Controllers configuration panel or taken from signal values. This allows tuning parameters to be linked to production recipes, which makes altering the controllers a fast and easy process.

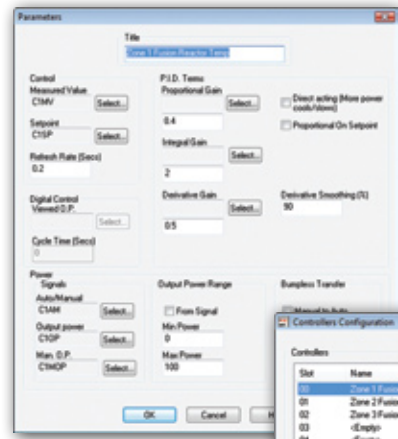

Prodigy's software controllers can be linked to each other or to external hardware controllers to provide cascade control.

Prodigy comes complete with a library of controller faceplates for many industry standard controllers. These can be used as a template for your own faceplates for other controllers or for Prodigy's software controllers.

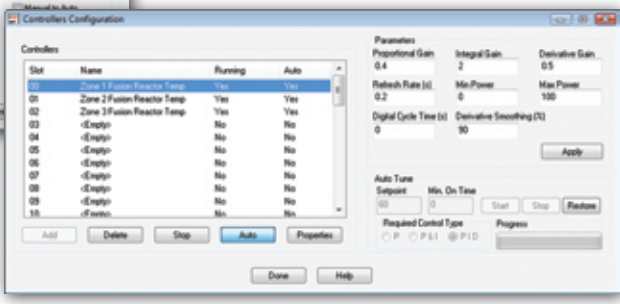

Automatic Test Sequence

Ideal for end of line test rigs and development test cells, ATS can even be used to perform multi-variable profile control in a wide range of industrial applications.

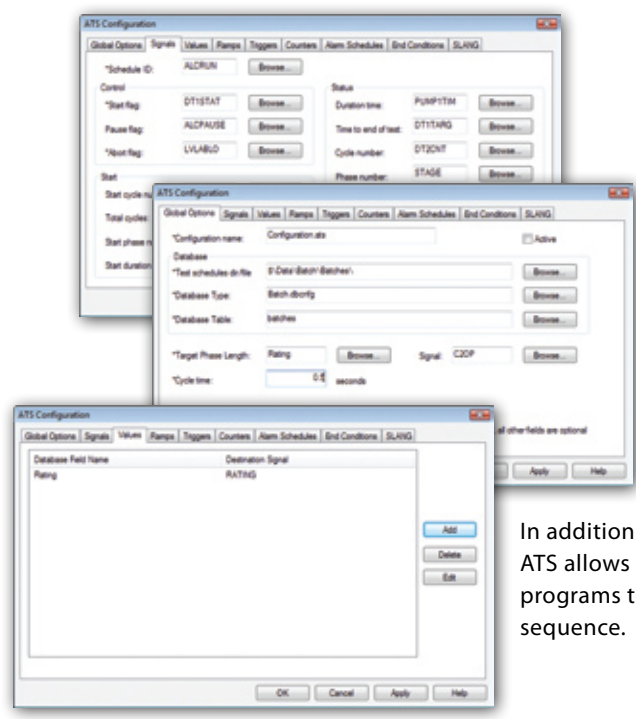

ATS is ideal for applications where the control sequence can be expressed as a sequence of stages, each with a range of control variables, ramp rates, dwell times, phase end conditions, etc. By using ATS you can provide the user with a simple spreadsheet into which the control parameters for each stage are entered.

By structuring the control sequence, applying range limits and using drop down lists it is possible to prevent the user from defining a control sequence that is out of specification.

In addition to the control of analogue and digital signals ATS allows alarm schedules and Prodigy Slang control programs to be incorporated as part of the control sequence.

Database Configuration

Signal Database configuration is quick and simple, thanks to the versatile editor provided with all Prodigy Development packages.

The spreadsheet style screen layout can be customised to suit the way you want to work and a powerful filter mechanism makes it easy to locate the required information even on the largest of signal databases. Its wizards will guide you through the editing process whilst built in knowledge of many manufacturers hardware will often remove the need to refer to user manuals for signal type and address information.

Go Live!

You can configure the database at any time, even on a live system. Once complete, simply press the Go Live button and Prodigy will create a roll back point, allow you to annotate the changes and load the new database. To see the effect of your changes, press the Monitor Mode button and the editor becomes a live view of your entire realtime signal database. If you're not happy with the changes you can roll back the database and Go Live with any previous database version.

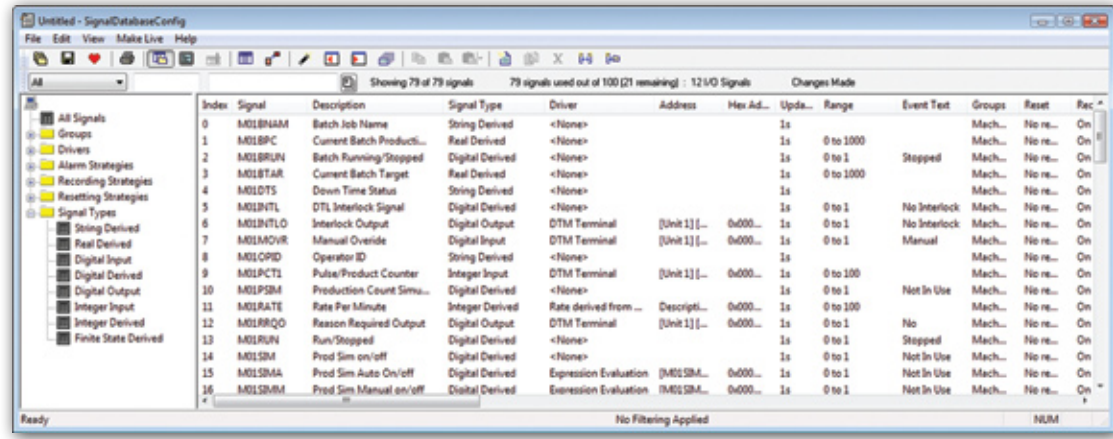

Configuration Manager

Prodigy provides system integrators with a way of managing several different customers configurations simply and efficiently.

As a systems integrator, you may have many projects ongoing at any one time and will have an archive of projects that are completed and out in the field but for which you will still be offering support. Prodigy's Configuration Manager allows you to keep multiple configurations on one PC and quickly switch from one to another with the minimum of effort.

Configuration Manager stores all of the information and files that form part of a project, including Prodigy itself. This allows you to support many different customers running different versions of Prodigy and still switch seamlessly between them, without the need to re-install the relevant version of Prodigy.

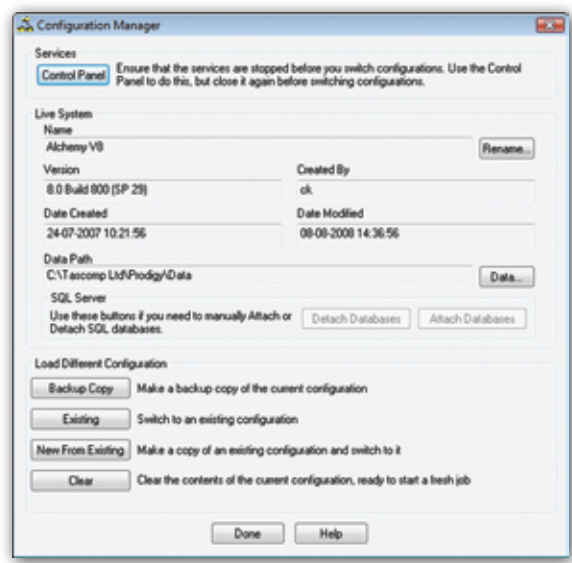

The Configuration Manager stores and displays information about each project being managed, including:

- The name of the system.
- The version of Prodigy used for that system.
- Who created the system.
- Date of creation and last modification.
- The location of the data path for this configuration.

Database Configuration

Spreadsheet display of entire database.

- Modify on a running system
- Go Live
- Edit/monitor mode
- Filter mechanism for large systems
- User defined layout

Configuration Manager

Multiple system configurations on one PC.

Supports different versions of Prodigy on one PC.

Single-point licensing for system integrator license.

Configurable common data location for all configurations.

Quick "new project" configuration.

Thermal Imaging

Supports serial and Ethernet based communications to thermal line scanners.

- Full colour thermal images
- User definable colour palette
- Thermographs
- 3D waterfall display
- Sector trends
- Realtime and historic display
- Direct data read-off
- Pre and post trigger data capture
- Alarm monitoring
- Automatic data analysis

Thermal Imaging

Integrated Thermal Imaging tools make Prodigy the ideal choice for most thermal processes.

Overview

Prodigy provides complete support for realtime thermal imaging for continuous or discrete processes. It can capture, display, record and analyse information from multiple thermal line scanners to provide live thermal images, production records, alarm monitoring, realtime analysis of production quality and early warning of manufacturing problems.

Whilst the core thermal imaging tools can be applied to any thermal process, a range of industry specific configurations have been specially developed to provide 'out of the box' solutions for most of the common applications. Full details are available on request.

Display Types

Prodigy provides a number of ways to view thermal data including realtime, full colour thermal images, Thermographs, 3D waterfall display and sector trends.

Data Recording

Data can be captured for long term storage based upon a range of continuous or batch based options. Scans can automatically include pre and post-trigger information based upon time or number of scan lines. Prodigy can maintain a rolling buffer of captured data, automatically deleting the oldest data to free up storage space and retaining key records for long term storage as required.

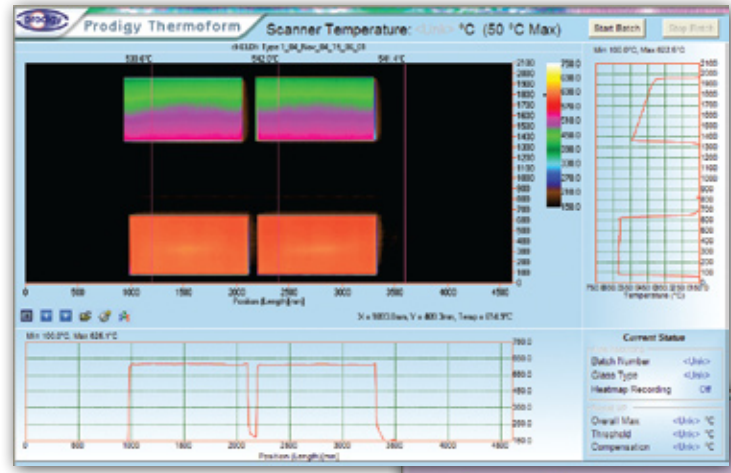

Automatic Data Analysis

Each scan can be analysed to check for manufacturing problems. This can include max, min & average temperatures, product surface area, part count, emissivity correction, hot/cold spots, etc.

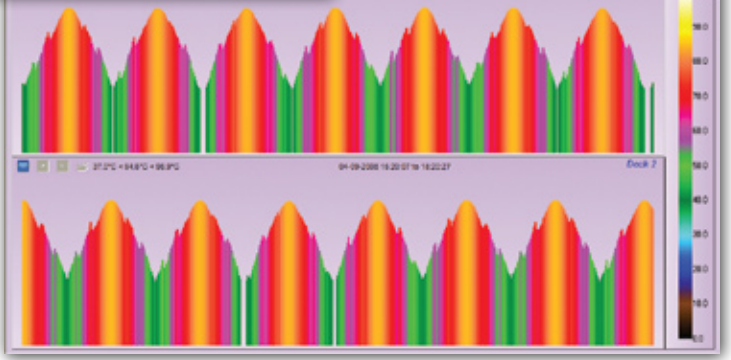

Fully integrated Solution

Unlike the simple software packages provided by equipment manufacturers, Prodigy is able to provide a fully integrated system. It can connect directly to your existing control and monitoring equipment to provide a range of capabilities which cannot be achieved using a stand alone package. This is why many original equipment manufacturers have chosen Prodigy as the basis for their own systems.

Expert Data System

Capture the knowledge of your best operators, engineers or consultants and make it easy to access by all users.

Expert Data System

EDS allows you to:

- Make expert knowledge available to all
- Reduce analysis time
- Improve product quality
- Reduce scrap levels
- Increase throughput
- Remove recurring problems

EDS provides:

- Unlimited decision trees
- On-line user help
- Save decision process for review
- Auto-answer selected decisions
- Possible to fully automate analysis process
- Realtime analysis
- Automatic fault rectification

Prodigy's Expert Data System (EDS), makes it easy to link together a series of questions and actions that allow all users to access the knowledge possessed by your best engineers and operators.

Capture the knowledge

Prodigy EDS allows you to organise your knowledge into any number of decision trees. The root of each tree is the problem that you need to solve. Below the root you define all the decision and action nodes needed to find the solution to each problem.

Access the knowledge

When a production problem occurs, the operator selects the decision tree related to that problem. They are then presented with a series of questions and possible answers. Some questions will provide simple multiple-choice answers. Where Prodigy can retrieve the answer to a question from its realtime or batch databases, the user will be offered that answer to help them make a decision.

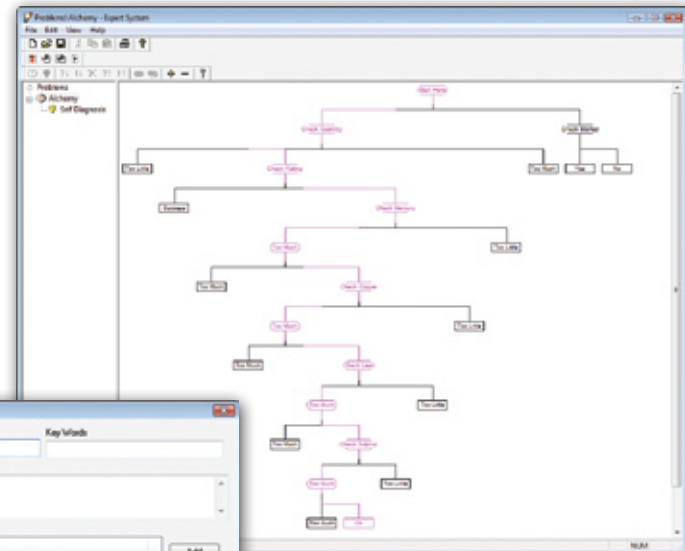

Two screenshots showing the configuration of decision trees. The top window is titled 'Decision Properties' and shows fields for 'Title', 'Question', 'Exit Paths', and 'Exit Route Definition'. The bottom window is titled 'Log' and shows a list of decision trees with their respective questions and actions.

Where the answer to a question may involve the user having to make a more difficult or subjective choice, Prodigy can be configured to offer assistance in the form of documents or pictures.

Automated Fault Diagnosis & Correction

Many questions will involve simple checks such as "Was the steam pressure OK", "How much water was added", etc. Often Prodigy will be able to retrieve the information needed to answer these questions from the realtime database or batch records. If sufficient process measurements are available to allow an entire decision tree to be answered in this way, then Prodigy's EDS can be configured to run this tree at regular intervals with the potential to spot a problem as it develops.

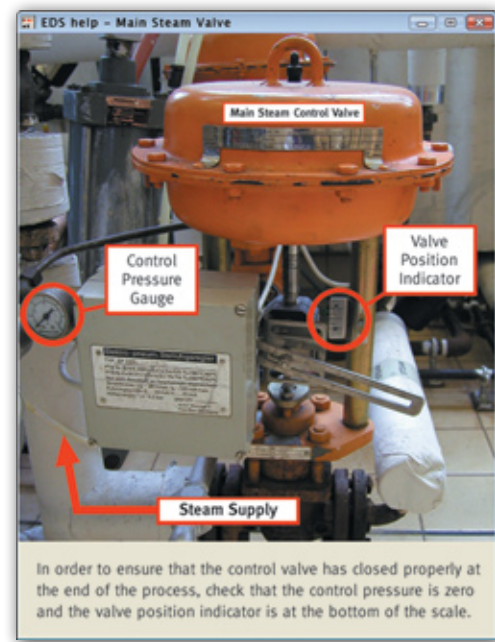

In order to ensure that the control valve has closed properly at the end of the process, check that the control pressure is zero and the valve position indicator is at the bottom of the scale.

Downtime Monitoring

Display

- Live factory display
- Realtime KPI
- Downtime Over Viewer
- Quick Statistics
- Andon displays

Report

- Automated OEE
- Downtime Analysis
- Production planning
- Pareto analysis
- Automated PA announcements
- SMS & email alarms
- Batch reporting

Interface

- Low cost hardware
- PLC interfacing
- Ethernet - RS485 - WiFi
- OPC client & server
- DTM series hardware
- Bar code readers
- Swipe cards
- RFID tags

Setup

- Configurable security
- HR logging
- Batch tracking
- Configurable shift patterns
- Automatic & manual data collection

Downtime Monitoring

Effective utilisation of assets is an essential step towards increased profitability. Prodigy provides all the tools needed to trap and log the information required to fully understand and measurably improve productivity.

Overview

By showing your entire production area on a single, live view, colour can be used to indicate problem areas where production efficiency is below target. By clicking on this plan view you can drill down to the information that shows the real reasons for lost production.

Prodigy can automatically calculate OEE (Overall Equipment Effectiveness), current machine efficiency, production rates, downtime and highlight problem areas through colour change, flashing graphics or traditional alarm mechanisms. By combining these displays with Prodigy's Online Maintenance facilities you can access the information needed to help rectify production stoppages or even prevent them occurring in the first place.

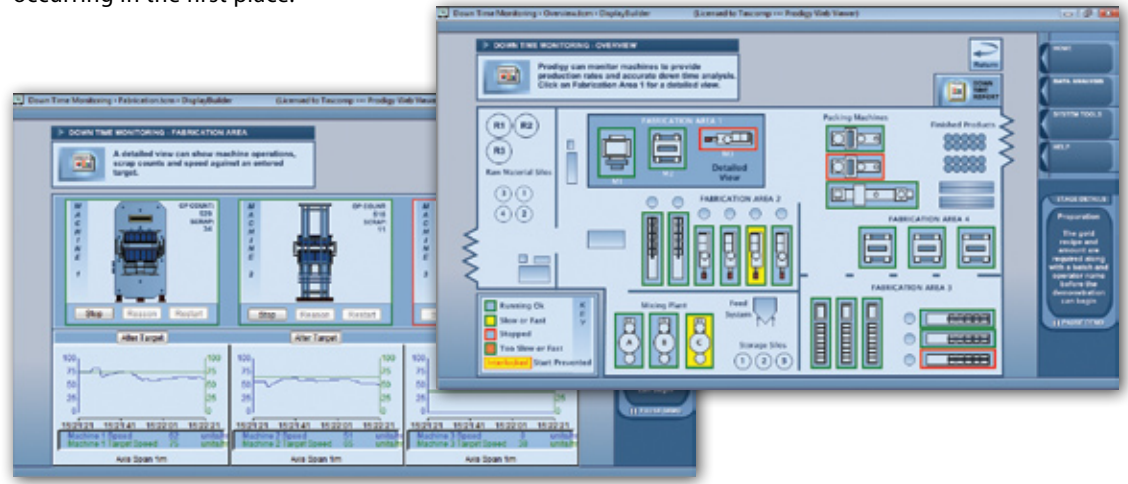

Downtime Logger

DTL forms the core of Prodigy's Downtime Monitoring facilities. It can simultaneously monitor any number of machines or production areas. When a stoppage occurs, it starts accumulating downtime. If the stoppage is too long it will activate an interlock that ensures a reason is entered for the lost production.

Downtime reasons may be collected automatically from PLCs or associated control equipment. Where automatic collection is not possible Prodigy can collect stoppage reasons from operators using either a PC or specially designed range of rugged operator terminals. DTL supports any number of downtime codes with sub-codes to help manage the data more effectively. DTL also recognises special machine set up codes that allow machine set up times to be tracked without interference from the downtime monitoring system. As well as monitoring individual machines or processes, DTL can even be configured to monitor linked production lines, handling the more complex requirements of inter machine buffering, materials re-stocking and cascaded interlocks.

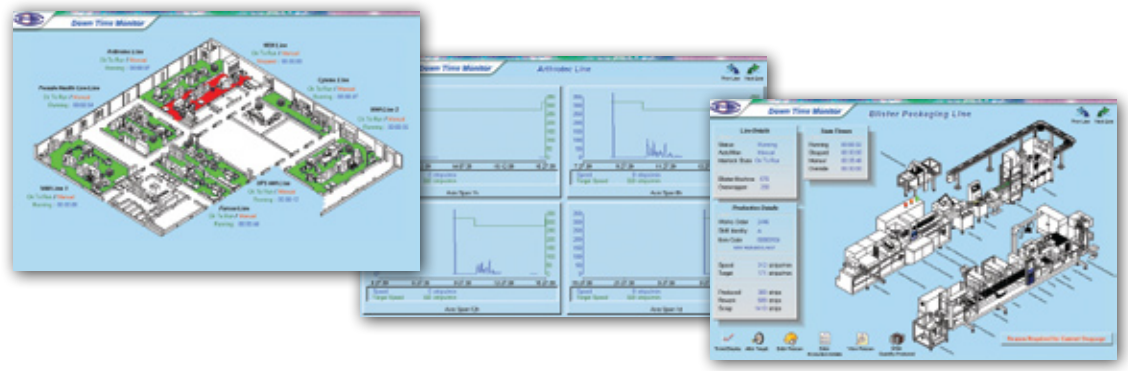

Downtime Viewer

Downtime Viewer is perfect for analysing production stoppages in more detail. Its powerful filter tools allow you to drill down through the data to find the root causes of production inefficiencies. It also provides tools to add/amend comments and combine/split stoppage events.

By using the Quick Stats tool, Prodigy will instantly calculate a wide range of frequently used metrics including total stoppage time, disturbance frequency, the top 5 losses by duration and number of events, etc.

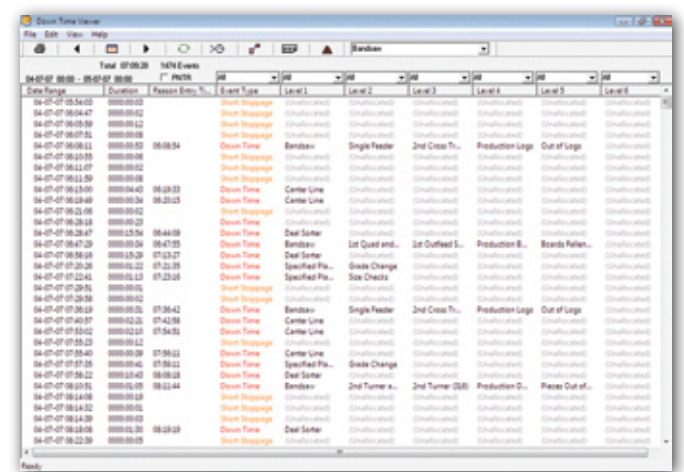

Downtime Over Viewer

Downtime Over Viewer gives you a live machine comparison, which highlights patterns and anomalies in performance that would remain hidden using traditional reporting tools. Coloured time lines for any number of machines give an instant running, stopped, no work scheduled, manual or override indication.



Viewed by shift, day, week or month you can easily see the patterns that would remain buried in pie charts, bar graphs and text based reports. Because this display is live, you can see at a glance how your entire facility is performing, allowing you to respond instantly to production disturbances.

Automatic OEE

Overall Equipment Effectiveness (OEE) is commonly used as a key performance indicator in conjunction with lean manufacturing techniques. Systems based on Prodigy software automatically collect the required data, calculate and report OEE in realtime. This automation ensures data accuracy, saves time and eliminates the errors and costs associated with manual data collection.



Downtime Reporting

The raw data collected by DTL is stored directly in a Microsoft Access™ or SQL Server™ database. This makes it easy to formulate reports that make the information easy to understand by highlighting the main areas of inefficiency. Prodigy provides a wide range of standard and user configurable data filters which automatically pre-process the machine data before the creation of management reports using Prodigy's Easy Report software.

Downtime Monitoring

Downtime Viewer

- View every stoppage event
- Selectable time periods
- Data filter
- Data drill down
- Quick data sort
- Quick Stats

Downtime Over Viewer

- Factory wide live status
- Group machine view
- Time based or totalised view
- Reason readout
- Machine statistics

Benefits

- Release hidden capacity
- Optimise uptime
- Minimise downtime
- Improve efficiency
- Increase profitability
- Optimise maintenance schedules
- Reduce costs

Architecture

Prodigy is a clean 32-bit application that is fully client/server based. It provides an event driven realtime response with millisecond time stamping. Its scalable architecture enables it to be applied to a wide range of requirements covering HMI, SCADA and DCS applications.

Drivers Included

Prodigy provides a wide range of standard drivers that allow it to connect to thousands of industrial devices. This includes PLCs, PID controllers, distributed data acquisition units and even industrial PC plug-in cards for direct digital control. All drivers and the OPC client and server are included free of charge with all Prodigy packages.

Scalable

Prodigy systems can start small, with just a single PC and the Prodigy Lite package, to provide a low cost, stand-alone HMI/SCADA system. Larger systems can make use of the Prodigy Classic and Complete packages to provide additional facilities as well as the Remote Workstation and Interconnect packages to create a distributed control and monitoring system.

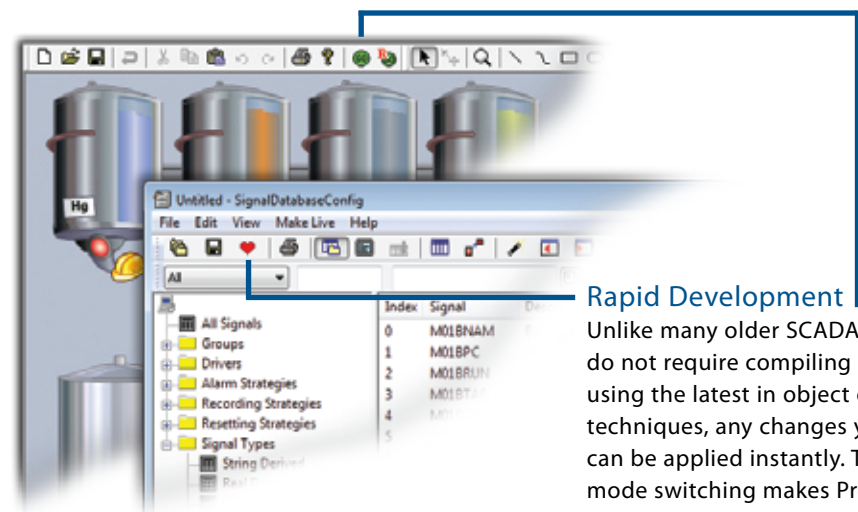
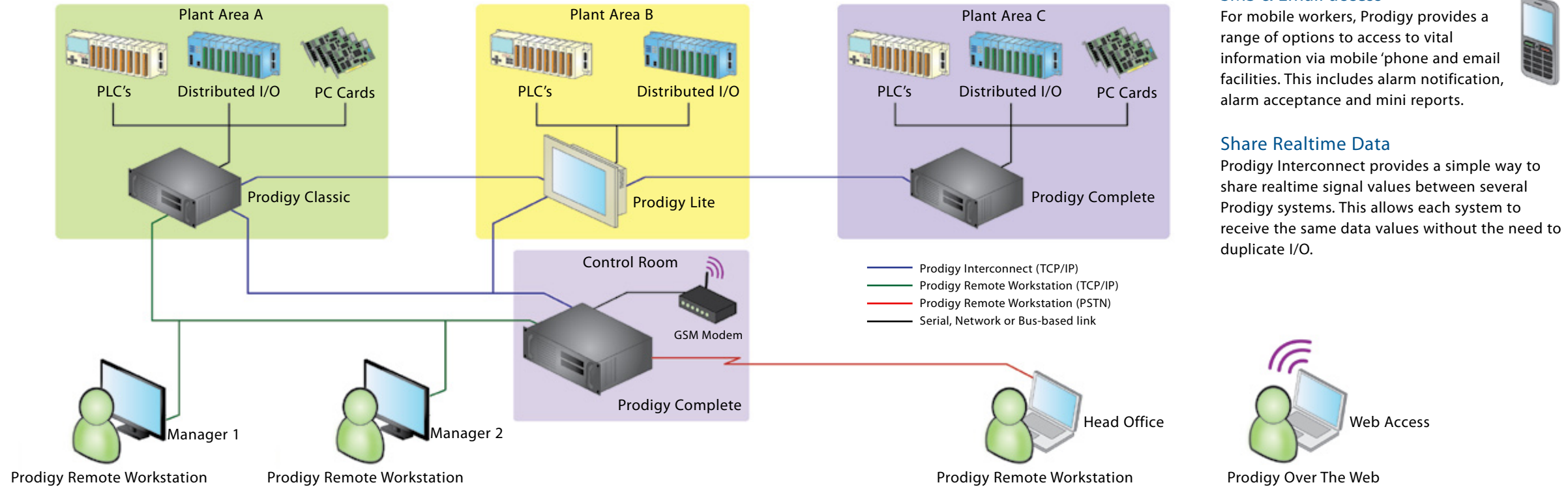

Rapid Development

Unlike many older SCADA packages, Prodigy systems do not require compiling before they can be run. By using the latest in object oriented design techniques, any changes you make within Prodigy can be applied instantly. This instant design-to-run mode switching makes Prodigy more interactive and significantly reduces development time. You can even edit the signal database on a working system and use the Go Live button to action the changes with no need to restart the system.

Dual Computer Support

For mission critical applications Prodigy offers true dual redundant architecture ensuring no loss of data in the event of a PC failure. During normal operation, both PC systems are kept synchronised to ensure that no data is lost in the event of a PC failure. A heart beat signal ensures that failure of either PC is detected quickly. Prodigy notes the time at which the loss occurred and uses this information to re-synchronise the dual systems once the fault has been rectified.

Accurate Timing

Prodigy time stamps all measurements at source. This allows it to keep the measurements original time stamp, or attach a PC clock time stamp as required.

SMS & Email access

For mobile workers, Prodigy provides a range of options to access to vital information via mobile phone and email facilities. This includes alarm notification, alarm acceptance and mini reports.

Share Realtime Data

Prodigy Interconnect provides a simple way to share realtime signal values between several Prodigy systems. This allows each system to receive the same data values without the need to duplicate I/O.

Remote Access

Prodigy Remote Workstation runs on any desktop PC and allows you full access to any Prodigy system on your network. Prodigy Workstation even works in conjunction with the Internet or dial-up networking to allow you to access Prodigy systems at remote sites.

Realtime Database

Prodigy's realtime database provides a central reference for all signal details such as tag, description, units, normal range, etc. This ensures that details are kept consistent throughout even the largest systems. Powerful tag search, substitution and grouping facilities help to speed system creation and significantly reduce development time.

Prodigy Over the Web

With Prodigy Over the Web, you can turn any Prodigy system into a live web server capable of providing remote access from any Internet Explorer enabled PC.

Software

Client/server architecture.

Rapid, event driven response.

Efficient realtime database.

Unlimited database size.

Distributed data access.

Local or remote data processing.

LAN, WAN, Wi-Fi or PSTN remote access.

Dual redundant and hot standby architecture for mission critical systems.

Runs on Microsoft Windows:

- 7
- 8
- 10
- Server 2016

Network & Remote Access

A range of packages are available that will allow you to access your Prodigy systems from any location via Ethernet, Internet or dial up connections.

Remote Access

Prodigy makes it easy for you to access live information, trends and reports from any location. By using industry standard TCP/IP connections, any number of remote users may access any Prodigy system without disturbing the normal operation of that system. Prodigy makes it easy to achieve these connections using your existing office network, wide area network or Internet connection.

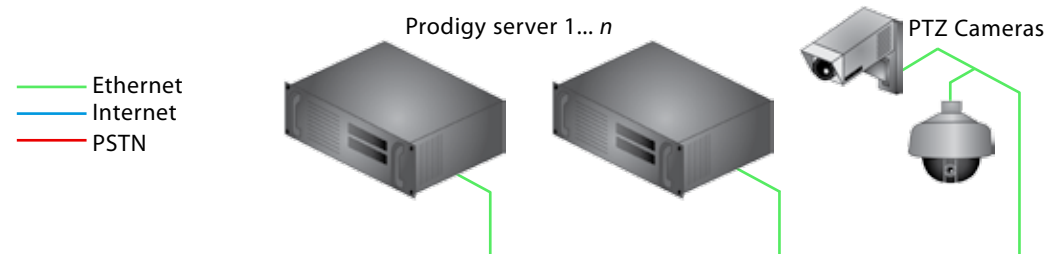

Remote Viewstation

Prodigy Remote Viewstation provides view only access to any Prodigy server. This remote view can match the facilities available on the target system or be configured to provide a custom view for each different user. As a view only connection you can be sure that remote users cannot take control of or modify the data on the target system. This is ideal for 'data consumers' such as senior management, Quality Control etc.

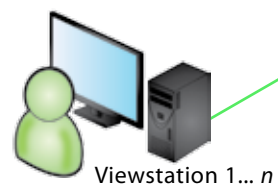

Remote Workstation

Prodigy Remote Workstation provides view and modify access to any Prodigy server. This can be customised to give precise control over the facilities which are available for each user. Remote Workstation provides full control over the target Prodigy server, allowing operators to control their plant from any location. This includes recipe control, alarm acceptance, report creation/generation, display creation, realtime and historic trending, etc.

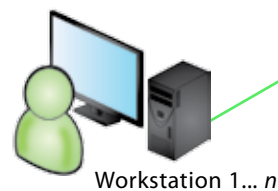

Interconnect

Prodigy Interconnect provides a simple way to share realtime signal values between several Prodigy systems. This allows each system to receive the same data values without the need to duplicate I/O.

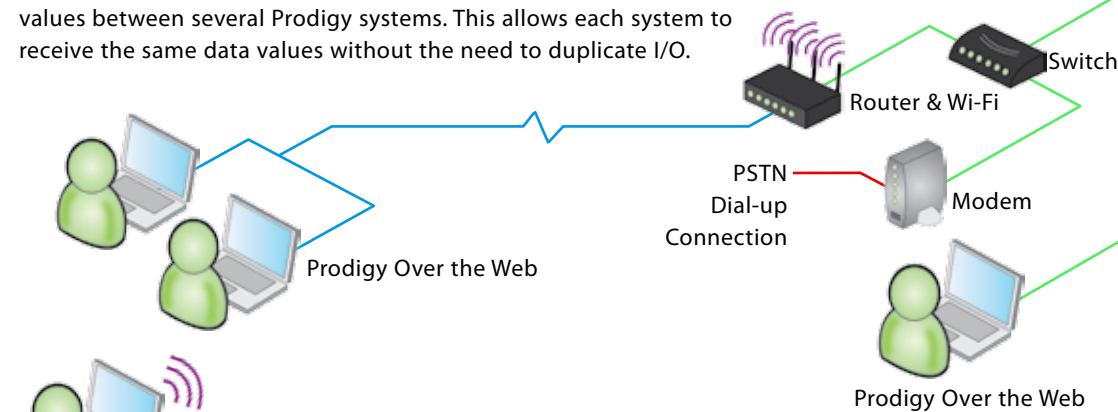

Prodigy Over the Web

Prodigy Over the Web (POW) allows you to view your displays and trends using Internet Explorer from any location, on site or around the world. Administrator controls allow user access to be unrestricted or password protected. For high security applications access may be further restricted by specifying the MAC address of those PCs which are allowed to access Prodigy Over the Web. Simply tick the POW server option in the Prodigy control panel and your system will become a web server, providing realtime displays to remote users. For security purposes, Prodigy maintains a log of each user access and provides administrator control over user names, passwords, access levels and user lockout.

Viewstation/Workstation/
Prodigy Over the Web

Prodigy Licensing

Prodigy is supplied in three forms, Lite, Classic, and Complete. Each is available as a development or runtime version.

▲ Lite

The Lite package is designed for HMI and simple SCADA applications. It provides all the core Prodigy modules which are listed in the side bar. This includes the same comprehensive set of I/O drivers that are supplied with all Prodigy packages. Using the Lite package it is easy to create interactive user displays, trend measured signals, monitor and record signal alarms. The Lite package also provides the Slang sequence control language that can perform a wide range of tasks including sequential process control and display animation.

■ Classic

Prodigy Classic builds upon the Lite package to provide the core facilities required for most standard SCADA applications. These include recipe and batch handling facilities, SMS Alarms to mobile phones, online maintenance, automatic data archive, alarm scheduling and a powerful historic trend package.

● Complete

As the name suggests, Prodigy Complete provides all of the Prodigy facilities in one package. The main additions to those supplied with Prodigy Classic are Proof-of-Process reports, downtime monitoring, Multigraph, SPC, timed/faxed/email reports, Expert Data System, display record/replay and FDA 21 CFR Pt11 compliance. It also provides an unlimited I/O and internal tag allowance to give unlimited growth potential.

Custom

Prodigy's flexible licensing mechanism allows you to create a package that exactly matches your requirements. For instance, you could purchase the Lite Runtime package and add recipe handling and batch data facilities as extra modules. As well as choosing additional modules, you can also specify additional I/O and internal tag allowances to match your individual requirements. For details of the custom module options and I/O-tag pricing please refer to the Prodigy Price List. License upgrades can also be ordered via the Internet, with your new license being delivered via email. Upgrades purchased in this way do not require Prodigy to be re-installed or any configuration changes to be made, simply install the license and the upgrade is complete.

License Registration

Prodigy licenses require registration within the first 30 days following installation. Registration can be achieved using telephone or email via your Prodigy supplier. Alternatively, a hardware dongle based license can be purchased which will automatically register the software to the machine it is installed on.

Development or Runtime?

The Development packages are required, as the name suggests, in order to configure and develop new systems. They provide access to the configuration section associated with many Prodigy facilities. The Runtime packages are ideal for completed systems where you will not be making regular configuration changes, or want to deliberately prohibit any changes from being made. Runtime licenses are also cheaper, saving you money on multiple machines that use the same configuration.

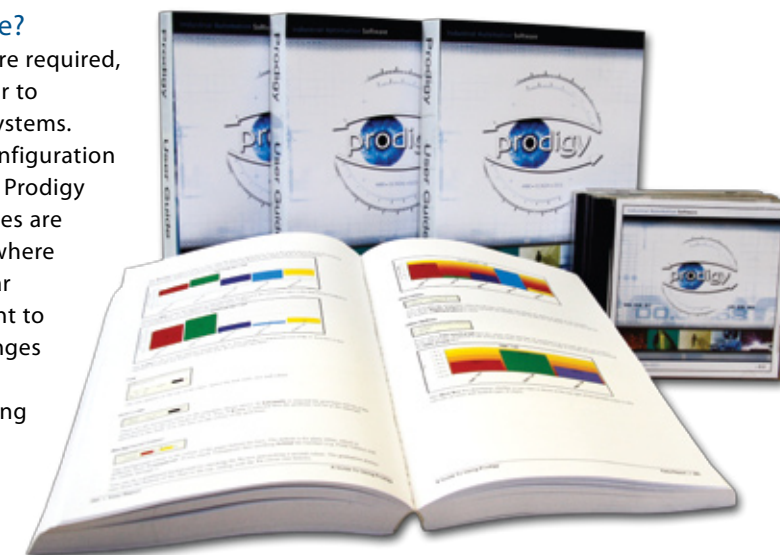

Options

DB + Menu + Security
OPC & All Drivers
Display Builder
Core Alarm Facilities
Realtime Trending
Slang Runtime
Slang Development*
Database Configuration*

Historic Trending
Batch & Recipe Handling
Easy Report
Online Maintenance
Automatic Data Archive
Alarm Scheduler
SMS1 - Alarm Output

Multi Trending
Proof-of-Process Reports
Downtime Monitoring
Profiles/Ideal Curves
Software Controllers
Automatic Test Sequence
Calibration Tracking
Shop Floor Terminals
SMS2 - Interactive
SPC
Event Recorder
Timed & Faxed Reports
Multigraph
Email Alarms & Reports
PDF Report Output
Display Record/Replay
Expert Data System
FDA 21 CFR Pt 11
SQL Server Support

* Development License

Facilities List

Core Modules

Realtime Database

- Unlimited tag allowance.
- Easy configuration.
- Spreadsheet import/export.
- Event driven displays.
- Millisecond time stamping.

Realtime Services

- Run as a service.
- Run as an application.
- Configurable start-up.
- System watchdog.
- Controlled shutdown.

Program Access

- Configurable toolbar.
- Multi-layer menu.

Security

- FDA 21 CFR Pt 11 compliance.
- User management.
- Definable privileged access to programs and/or functionality.
- User change logs.
- Comprehensive audit trail.
- Password protection.

Accessibility of Data

- Data available to external clients (ODBC, CSV, DDE, OPC, SQL).

Display Builder

Object Oriented, Drawing Primitives

- Connected line segments.
- Rectangles.
- Rounded rectangles.
- Ellipses.
- Closed polygons.
- Text.
- Buttons.
- Bitmaps.
- Trends.
- Heatmaps.
- Intelligent objects
- XForms.
- Gradient fill.
- Transparency.

Drawing Tools

- Composite objects.
- Grouped objects.
- Duplication.
- Alignment.
- Spacing.
- Sizing.
- Z-Ordering.
- Configurable refresh rates.
- Tag search & replace.
- Customisable library.
- Zoom & pan.
- Undo/redo edit commands.
- Pop Up Displays.

Display Builder

Dynamic Attributes

- Visibility.
- Flash.
- Percentage fill.
- Event driven displays.
- Millisecond time stamping.
- Line colour.
- Line length.
- Line thickness.
- Size.
- Position.
- Orientation.
- Button actions.
- Slider actions.
- Text/numeric value display.
- Tool Tips.

Animation Timers:

- Sine, square, triangle and saw tooth wave forms.

Operator Interactions

- Set signal values via:
- Buttons.
- Sliders.
- Forms.
- Dialogs.
- Start/Stop batches.
- Save trend configurations.
- Display maintenance info.
- Highlight over "clickable" items.
- Enter comments.
- Switch between displays.
- Run reports.
- Call up trends.
- Accept alarms.

Trend Graphs

Realtime Trending

- Unlimited Signals per Trend
- Pre-selected time spans.
- Runtime configuration save.
- Current value read-off.
- Programmable refresh rate.
- Manual/auto axis scaling.
- Temporary tag substitution

Historic Trending

- Tag aliasing.
- Average & Peak mode.
- Access via batch ID.
- Absolute & Relative time.
- Realtime comments.
- Zoom & pan.
- Manual/auto axis scaling.
- Realtime smoothing.
- Data scrolling.
- Data read-off.
- Signal value.
- Alarm state.
- Automatic or manual value.
- Display control limits.
- Dynamic link to SPC tools.
- Unlimited historical data.
- CD-R/DVD option.
- Print on demand.
- Intelligent recording strategies.
- Ideal curve overlay.
- Dual trend overlay.
- CSV data export.

Alarms

Alarm Displays

- Displays alarms & events along with the time they became active and the current state of the alarm.
- Permanent banner on display at all times, even when configuring system.
- Full screen display, showing all unaccepted alarms and events in chronological order.

Alarm Acceptance

- Restricted to permitted users.
- Automatic alarm acceptance.
- Recorded with time stamp and name of operator to provide full acceptance history.

Configurable Strategies

- Four alarm regions.
- Deviation alarms.
- Time delayed alarms.
- Alarm priorities.
- Definable as part of signal characteristics.
- Configurable as Alarm Schedules for different product criteria.
- Can be disabled during production changeovers, run up, etc.
- Alarm nag.

Annunciators

- Unlimited distributed annunciators.
 - Can trigger other events, e.g. faxed reports.
 - SMS and email alarm alerts.
- ### Recording
- Can be recorded as part of batch information.
 - Can be recorded to provide a full history of alarm and event conditions in a system.

FDA 21 CFR Pt11

Comprehensive support for:

- FDA 21 CFR Pt 11.
- GAMP 4.
- GLP.

Facilities include:

- Unique single click set up.
- Comprehensive audit trail.
- Audit reporting.
- Audit analysis.
- Automatic archive.
- Unique user I.D.
- Automatic password expiry.
- Operator comment log.
- Time operator logout.
- Auto tamper logout.
- User barring.
- User access log.
- 128 bit data encryption.
- No commercial decryption tools.
- Secure file browser.
- Desktop lockdown.

SPC

SPC facilities include:

- Raw data view.
- Distribution histogram.
- Average & range chart.
- Median & range chart.
- Individual & range chart.
- Specification limits.
- Checks for loss of statistical control.
- Non-normal distribution.
- Out-of-spec values.
- Run-rule violations.
- Machine capability.
- Process capability.
- Multiple data sources.
- Prodigy recorded data.
- Externally produced data (via CSV files).
- Manual data entry.
- Direct access via Historic Trends.

Expert Software

- Capture knowledge.
- Access knowledge.
- Unlimited knowledge base.
- On-line assistance.
- Manual or auto run mode.
- Graphical knowledge tree.
- Decision audit trail.
- Automated answers.
- Reduced down time.
- Increased productivity.

Software Controllers

- Unlimited PID controllers.
- Autotune.
- PID terms from recipe or control panel.
- On/off or analogue control.
- Auto/manual power control.
- Bumpless transfer.
- Profile control.
- Cascade control.
- Standard controller faceplates.

Automatic

Test Sequence

- Multi stage (profile) control.
- Spreadsheet data entry.
- Up to 250 control variables.
- Unlimited stages.
- Conditional branching.
- Set point ramp and dwell.
- Conditional stage termination.
- Loop 'n' times.
- Simple secure set up.
- End-of-line testing.
- Product development testing.

Event Recorder

- Record event sequence.
- Millisecond accuracy.
- Event filter.
- Record on signal group.
- Colour coded events.
- Event export to CSV file.

Sequence Control

Language (Slang)

Powerful, easy-to-use editing environment

- Multiple program threads.
- Integrated program control.
- Controlled shutdown facility.
- Integrated debug facilities.
- Numeric & string data types.
- Realtime signals, Local/Global variables, Constants, Macros.
- Single step debugging.
- Programmable break points.

Comprehensive instruction set

- Set/Turn.
- Lock/Unlock.
- Wait For/Until.
- If-Else-Endif.
- Repeat For/Until/Forever.
- Go-to/Label.
- Call/Routine/EndRoutine Return.
- Stop/Start.
- Arithmetic expressions.
- Data arrays.
- Conditional expressions.
- Expandible library of external function calls.
- Colour-coded program printout.
- Global routines.
- # include files.

Downtime Monitoring

- Automatic monitoring of stoppages to provide accurate timings.
- Assignment of any number of downtime reasons to stoppage periods.
- Configurable to ensure that short stoppages don't impede production rates.
- Machine interlocks used to improve data quality.
- Interlock override facility for maintenance & machine set up.
- Downtime data recorded to shift based, daily, weekly and monthly batches.
- Can include production data, e.g. product type, crew, quantity of scrap produced.
- Downtime reasons can be entered through Mimics and Forms, or through shopfloor terminals located on machines/production lines.
- Reports can be produced summarising periods of time, broken down to show the different downtime reasons and production rates.
- KPI & OEE calculation.

Facilities List

SMS1

Send alarms to mobile phones via PSTN modem

- SMS alarm indicates:
- Plant area.
- Alarm date.
- Alarm time.
- Alarm condition.
- Current measurement.

SMS2

Interactive alarms and reports via GSM modem

- No landline required.
- Receive alarms via text messages.
- Secure alarm acceptance.
- Log on/off from mobile phone.
- Request mini process reports.
- Receive process reports on your mobile.

Thermal Imaging

Thermal Line Scanner Interface

- False colour thermal image.
- "Waterfall" display.
- Scan profile.
- Single point profile.
- Zone alarms.
- Min/Max/Average tracking.
- Multiple scanner configurations.
- Save/Replay scanned images.
- Autosave facility, based on trigger signals.
- Pre-trigger history and post trigger run on.
- Thermographs.
- Data read off.

Plant Maintenance

Provide maintenance & training information through:

- Formatted documents, held locally or remotely through a network link to a controlled (read-only) version.
- Standard Operating Procedures (SOP).
- Work Instructions.
- Technical Specifications.
- Annotated photographs e.g. of the plant, making equipment easier to locate and repair.
- Video images e.g. showing disassembly and re-assembly procedures.
- Plant runtime/operations tracking.

Report Generation

Report On

- Batch data.
- Engineering test data.
- Batch alarms.
- Historic alarms.
- Downtime data.

Flexible Formats

- Text.
- Charts.
- Graphs.
- Timed report generation.
- Automatic batch reports.
- Faxing option.

Batch & Recipe Handling

Automatic Batch Creation/Completion

- Automated batch name generation.
- Multiple start/stop criteria.
- Data initialisation on batch start.
- Initial data logging.
- Repeated intermediate data logging.
- Final data logging.
- Data re-initialisation on batch end.
- Continuous data storage.

Recipe Handling

- Unlimited recipes.
- Read/write database.
- Read/write signals.
- Download to PLC/controller.
- Configurable reports.

Proof-of-Process

Single page report format. Show all key data from a batch run.

- One off data.
- Recipe data.
- Alarms.
- Trends.
- Fully integrated with Batch Recorder for automatic report generation.
- Supports tag aliasing.

Profile Curves

User-definable

- Flexible drawing tool.
- Direct entry of point data.
- Export real data to produce ideal curve.

Overlay onto process trends

- For "Ideal Curve" comparisons.

Controller downloadable, including

- Dwell time.
- Setpoint.
- Ramp rate.
- Auxiliary output control.

Remote Data Access

Multiple Prodigy systems communicate via:

- LAN/WAN/Dial-up connections.
- TCP/IP protocol.

Prodigy Workstation

- Desktop PC acts as remote workstation.
- Viewstation option.
- Optional control access.

Web Viewing

- Prodigy Over the Web. Use internet explorer to view any Prodigy server.

Prodigy Interconnect

- Distributed realtime database.
- Multiple systems share live data.

Remote Data Entry/Viewing

- Via compact, rugged, industrial data entry & display terminals.
- Redundant Hot-Swap Option.

Plug-in Modules

- PID control.
- Downtime logging.
- Machine utilisation.
- Manual data entry.
- Thermal imaging.
- Calibration tracking.
- Statistical Process Control.
- SMS alarm output.
- SMS interactive.
- Email interactive.
- Expert analysis.
- Automatic test sequences.

Drivers

Host of drivers, covering:

- Serial I/O devices.
- Ethernet I/O.
- PC plug-in cards.
- Software derived devices.
- Custom driver development.
- OPC Client & Server included
- Contact your supplier for a complete up-to-date list.

Hardware Platform

- 2GHz processor or higher.
- 512Mb RAM.
- 1Gb free disk space.
- Microsoft Windows™

Application Support Team

Tascomp recognises that all businesses have their own unique requirements. Whilst Prodigy provides a comprehensive range of facilities in its standard form, Tascomp have established a support team that can provide **Fast Track Development** courses to help you develop your application, write communications drivers or create new facilities to meet your most demanding requirements.

Custom Development

Do you have a special requirement or need your own brand identity? Prodigy is now sold under many different brand names, each incorporating the special capabilities needed by our customers. These customised facilities have been created by the Prodigy software development team.



Distributor Network

By selling Prodigy through approved distributors and system integrators around the world, Tascomp ensures that first line support is available to end users in their own language and time zone.

All Prodigy distributors and system integrators are fully trained to ensure that this support is of the highest standard. This is backed up by direct telephone and email access to the Prodigy development team, ensuring that all enquiries are resolved quickly by people who are fully conversant with the Prodigy package.